



University of Idaho
Extension



Elmore County 4-H

Horse Rule Book

2023 - 2024





4-H Youth Development

Connor Cox, Extension Educator

Nadine Cook, 4-H Program Coordinator

Jamie Davis, 4-H Program Assistant

535 East Jackson

Mountain Home, Idaho 83647 (208) 587-2136 Ext. 1251

Email: cookn@uidaho.edu

Website: www.uidaho.edu/extension/county/elmore

Facebook: UI Extension 4-H Elmore County

It is U of I policy to prohibit and eliminate discrimination on the basis of race, color, national origin, religion, sex, sexual orientation and gender identity/expression, age, disability, or status as a Vietnam-era veteran. This policy applies to all programs, services, and facilities, and includes, but is not limited to, applications, admissions, access to programs and services, and employment.

Persons with disabilities have the right to request and receive reasonable accommodations. Please complete this [form](#) to assist in evaluating the reasonable accommodation request at least two weeks prior to the event. Accommodation applications cannot be approved without supporting documentation. Submit this electronic request form by sending the application and documentation to Center for Disability Access and Resources 875 Perimeter Drive Moscow, ID 83844-4257 cdar@uidaho.edu Phone 208-885-6307, Fax 208-885-9404

Table of Contents

GRIEVANCE PROCEDURE.....	4
Code of Conduct for Parents, Volunteers and Youth	4
ELMORE COUNTY POLICY.....	5
4-H AGE DIVISIONS	5
CLOVERBUD GUIDELINES AND POLICY.....	6
PORTFOLIOS & RECORD BOOKS	6
GENERAL 4-H/FFA RULES	7
SHOW GUIDELINES	8
GENERAL HORSE RULES & REGULATION.....	9
PROJECT COMPLETION REQUIREMENTS.....	11
DRESS CODE.....	11
AWARDS.....	13
SHOW PROTOCOL	14
PROJECT ANIMAL.....	15
STABLE AREA & WASH RACK	17
Tack	18
SHOWMANSHIP	23
Mini Showmanship.....	26
MINI HORSE IN HAND POLES, IN HAND BARRELS	31
MINI HORSE KEYHOLE-INHAND.....	32
ENGLISH DISCIPLINED RAIL	32
ENGLISH EQUITATION.....	33
BAREBACK EQUITATION(English)	35
ENGLISH PLEASURE/ HUNTER UNDER SADDLE.....	35
HUNTER HACK.....	36
OVER FENCES EQUITATION.....	37
TRAIL (Western or English Attire).....	40
In-Hand Trail (Western or English Attire).....	42
Western Disciplined Rail.....	45
WESTERN EQUITATION	46
BAREBACK EQUITATION (English or Western)	47
WESTERN PLEASURE.....	48
WESTERN RIDING	49
REINING	50
WORKING RANCH HORSE VERSATILITY.....	56
FREESTYLE REINING	66
COSTUME CLASS	67
DUTIES OF SHOW STAFF	67
Appendix	69
Dog & Horse Verification of Vaccines.....	69

This rulebook is a guide, which provides leaders, parents, and members with minimum expectations of what must be done to complete 4-H projects, compete successfully, and how the show will be conducted. The rules are necessary in order to provide an opportunity for members to fully demonstrate their skills. They also serve as a guide to all the volunteers who give generous amounts of their time to conduct the show. Any rule in this book will stand as printed.

It is the responsibility of each leader, parent, and member to be aware of the University of Idaho Policies and Procedures, the Elmore County 4-H Rules, and Elmore County Fair Board Rules.

GRIEVANCE PROCEDURE

Grievances will be handled through the individual working groups and Leader's Council with notification to the Extension Educator and 4-H Program Coordinator. If the grievance cannot be solved within the working group, it will then go to the Elmore County 4-H Leader's Council with notification to the Extension Educator and 4-H Program Coordinator for review.

During the fair, the working group chairpersons have the authority after thorough problem identification and notification to the Extension Educator and 4-H Program Coordinator to make decisions concerning problems presented to him/her. If any decision is disputed, the chairman will provide the grievance procedures as above.

Code of Conduct for Parents, Volunteers and Youth

Within the Idaho 4-H Youth Development Program

(As Found on 4-H Online)

Idaho families and youth trust the University of Idaho Extension system to provide educational programs in a safe environment for all participants. The opportunity to participate in and/or work with Extension's Idaho 4-H Youth Development program is a privilege and an honor, not a right. Volunteers are to be positive role models. Youth and parents/guardians are expected to demonstrate appropriate behavior at all times. The following Code of Conduct has been established as the foundation for all individuals participating in University of Idaho Extension programs.

All Idaho 4-H Youth Development program participants are expected to:

- Work with youth, families, volunteers, and Extension personnel in a cooperative, courteous, respectful manner demonstrating good sportsmanship and behaviors appropriate for a positive role model.
- Accept supervision from Extension personnel and cooperate with others; in addition, parents and youth will accept supervision from certified organizational and project leaders.
- Maintain open, honest communication with members, leaders, parents, and Extension personnel.
- Uphold every individual's right to dignity, appropriate self-expression, and individual development.
- Refrain from verbal or physical abuse of others and report such abuse, if observed. Any actions, such as conviction for child abuse or neglect, violent crimes, unethical behavior, substance abuse, verbal abuse, physical abuse, mismanagement of 4-H funds, or other serious offenses will not be tolerated.

- Respect, adhere to, and enforce the rules, policies and guidelines established at the county and state levels for the 4-H Youth Development program.
- Promote the spirit of inclusion and welcome participation of other individuals from all backgrounds. Comply with equal opportunity and anti-discrimination laws.
- Refrain from consuming alcoholic beverages, use of tobacco products and/or a controlled substance at 4-H events and activities. Being under the influence of alcohol or illegal drugs while in the presence of 4-H members at or during 4-H programs or activities is not acceptable.
- Inform Extension personnel of any incidents that may violate 4-H policies.
- Treat animals humanely and encourage all participants to provide appropriate and ethical animal care.
- Operate machinery, vehicles, and other equipment in a safe and responsible manner when working with youth and adults participating in 4-H/Youth Development programs.
- Ensure that 4-H participants are not required to purchase materials, equipment, animals, or services from any specific places of business.
- Comply with all applicable laws of the city, county, and state of residence and/or location of 4-H activity.
- Handle all concerns regarding county/area 4-H program management internally within the University of Idaho Extension system.

Violating the Code of Conduct shall be grounds for action up to or including immediate removal from the 4-H activity/program and termination. Decisions regarding immediate removal, suspension or termination will be made by county Extension office personnel with subsequent notification of and consultation with the District Director and State 4-H Director. Volunteers who wish to appeal a decision may do so through the Appeal Process.

ELMORE COUNTY POLICY

All 4-H/FFA members must be enrolled, and fees paid by March 1st to show and sell at the fair.

4-H AGE DIVISIONS

Elmore County 4-H members are grouped (based on ages as of January 1) as follows:

- **Clover Bud** - 5 to 7 years old (**Cannot be on or around horses**)
- **Junior** - 8 to 10 years old
- **Intermediate** - 11 to 13 years old
- **Senior** - 14 to 19 years old (**must still be in high school**)

Walk Trot:

Any age riders will be asked to walk and trot only. No loping. 1st and 2nd year only.

- If a member elects to participate in walk-trot classes, the member cannot also participate in the same class in the age division classes.
- For the safety of the horse and rider, members may stay in division for a 3rd or 4th year with the approval of their leader.
- Walk trot cannot show a green horse for safety reasons.

- Not eligible for the Working Ranch Horse Program.

Green Horse:

- Any horse, regardless of age under a saddle for 2 years or less.
- Green horse can only compete in green horse classes.
- Exceptions for the number of years under saddle is upon discretion of the Horse Working Group.
- Green Horse Checklists are required
 - Levels 1 & 2: In Hand Showmanship (**must be completed in order to advance to level 3**)
 - Levels 3 Green Horse Walk Trot
 - Level 4: Green Horse Lope
- Division 1 Green Horse: Walk Trot
 - Any green horse in its first year of training under a saddle, unless exception is approved by leader and parent to move to Division 2.
- Division 2 Green Horse: Lope with permission of leader and parent
 - Any green horse in its second year of training under saddle

CLOVERBUD GUIDELINES AND POLICY

The Idaho 4-H Clover Bud Program is offered for boys and girls who are between 5 and 7 years old by January 1st of the current 4-H year.

Clover Bud members may be involved in lap animal projects. These are defined as: rabbits, cavies, cats, chickens, mini-goats, or small dogs that weigh less than the member at fair time.

Fair exhibits by Clover Buds are non-competitive and are optional. A Clover Bud Memory Book (63013) is available to be used with fair exhibits but is not required. A participation ribbon or small recognition may be given.

PORTFOLIOS & RECORD BOOKS

1. For Project Completion each member must turn in a completed portfolio which includes a completed record book and all other required forms for each project. See portfolio checklist in the appendix for more information.
 - A completed record book is required for every 4-H project exhibited at fair.
 - Record books and all other required forms will be displayed in a Green 4-H portfolio cover and in order according to the portfolio checklist (see appendix)
 - The record books need to have all sections filled in and need to be signed by the member, leader, and parent to be considered complete.
 - Signature by the leader verifies that the member has completed the requirements.
 - One (1) overall 4-H experience story is required (one story including experience in all projects)
 - One project photo is required for each project.

2. Each member must participate in a 4-H planned community service project and record it in their involvement report.
3. Each 4-H member must attend at least 6 club meetings and do a demonstration for each project.
 - Horse members must attend a minimum of 10 club meetings, of which at least 6 must be riding meetings
 - If a parent is the leader, a member must have at least 3 of the 6 required meetings with a club.
4. Each member must complete the required number of Animal Science Lessons, CCS Book activities, or other project manuals in order to exhibit and sell at the fair.
5. It is the leader's responsibility to verify completion of Animal Science Lessons and/or activities.
 - Animal Science Lessons must be recorded on an animal science checklist with leader's initials
 - One checklist must be included with the first animal record book.
 - Members with multiple species checklist must record species specific animal science lessons in the activity log of each record book.
 - Lessons completed must be applicable to the species of animal that the exhibitor is showing
6. It is required for members to include CCS Book (when project requires) in the Portfolio for exhibit at the Elmore County Fair. The CCS books will not be judged but will be checked for completion of required activities.
7. All members are required to participate in a record book interview in order to exhibit and sell at the fair.

GENERAL 4-H/FFA RULES

1. Underage consumption of alcoholic beverages will not be tolerated at any time and could be grounds for dismissal from the 4-H program.
2. Any 4-H/FFA member disqualified from the shows for unsportsmanlike behavior or failure to comply with the fair/4-H rules will not be able to sell their market animal. Leaders will report to the species chairman and the chairman together with the leaders will investigate the issue.
3. Parents or leaders engaging unsportsmanlike behavior or failure to comply with fair/4-H rules will be asked to leave. If there are problems, the fair board will be contacted, and the individuals will be escorted off the fairgrounds. If problems persist, the police will be called in.
4. Disrespect shown to any judges or fair official may result in forfeit of all awards made to the offending exhibitor and that person will be asked to leave the grounds. Disrespect shown to any judge or fair official by parents/leaders will result in being asked to leave the fairgrounds. If there are problems, the fair board will escort the individual off the fairgrounds. If problems persist, the police will be called in.
5. Judges will be carefully selected and approved by the Elmore County 4-H Working Groups, the Elmore County Extension Educator, and 4-H Program Coordinator.
6. In all cases, the decision of the judge is final.
7. Each club is to have a representative (leader, parent, or teen) at each leader's council meeting.
8. Chairmen have 1st preference for fair campsite, 2nd preference is leaders and parents who attend 75% of Leader's Council Meetings (8 meetings), 3rd preference is leaders and parents who attended 7 meetings and on down to 1 meeting. If campsites are still available, names will be drawn out of a hat for anyone else.

9. To be eligible for a campsite parents must sign a waiver stating they will be on the grounds with their child at all times.
10. FFA exhibitors participating in the Fair are expected to follow 4-H rules and regulations, except in cases of conflicting program requirements.
11. Leasing of animals is permissible. A non-family-owned animal must be managed by the member by the member at least 80% of the time for the required number of days for the species. This includes feeding, grooming, exercising, training, and access to use. Members with non-market animals must have a lease agreement filled out and on file with the Elmore Extension Office. Market animal members with sponsorships must have a financial agreement filled out on file with the Extension Office.
12. 4-H and FFA class entries may only be for projects in which the member is currently enrolled.
13. The use of cell phones or other electronic devices are not allowed in any show. If a member uses a cell phone or other electronic devices in any show, it will be considered an infraction of the dress code and left up to the discretion of the judge in placing.
14. The exhibitor-owner of any livestock or property of any kind brought to the fairgrounds, either for exhibit or for other purposes, assumes, as a condition of its admission to the grounds, all risk and responsibility for its loss, theft, damage or injury to himself/herself or property, or injury to any person or the property of any person by the exhibitor-owner's animal. Exhibitors exempt the Elmore County Fair Board, The Elmore County Extension Office, Elmore County 4-H Leaders, their officers, directors, and employees from liability for any loss, theft, damage, or injury to himself/herself, property, any person, or property by any animal owned or exhibited by the exhibitor. The exhibitor shall indemnify the County Fair against all claims and any injuries or damages arising from the actions or negligence of the exhibitor.

SHOW GUIDELINES

This book addresses rules for the Elmore County 4-H Horse Program. This book includes 4-H horse requirements and classes at the Elmore County Fair and Elmore County 4-H Invitational Shows.

Show Classes:

Any or all the classes listed in this guide may be offered at a show or fair where 4-H classes are conducted. At pre-fairs, county fairs, or any state qualifying event, showmanship is required.

Class Priorities:

When management must choose between equitation and pleasure classes, equitation classes must take priority. For example, western equitation and bareback equitation must be offered before western pleasure. If entries warrant, saddle seat or hunter seat equitation must be offered before English Pleasure Classes. If entries warrant, it is recommended that all shows offer at least two equitation classes and a showmanship class. For example: western equitation, bareback equitation, and showmanship.

Participation:

- To participate at district or state fair, an exhibitor must use the same horse that was exhibited at the county fair.

- County committees may make accommodations for special circumstances at county 4-H events.
- State committees may decide if country accommodations are eligible for respective state 4-H events.
- Show management may invite participation from public or other 4-H clubs outside the county for invitational shows or playdays only. Only Elmore County 4-H members may attend the Elmore County Fair as exhibitors.

GENERAL HORSE RULES & REGULATION

1. Only 4-H project horses are allowed during 4-H sponsored fair events.
2. **Only 4-H members may ride, groom, school, or handle a horse while on the fairgrounds during 4-H sponsored fair events. Junior members may have assistance with saddling and bridling if needed. Anyone may have assistance for safety reasons.**
3. No one is allowed to coach contestants while the contestants are in the show ring.
4. The humane treatment of all animals is required. Exhibitors are expected to treat their animals with respect and provide for their continuous well-being through proper feeding, handling, disease prevention, sanitation, and attention to safety.
5. Exhibitors must always keep their horses under control. Unmanageable animals, unnecessary roughness, or abuse of the animal may dismiss the 4-H'er from further competition. No animal may be shown at the Elmore County Fair that would endanger the public safety.
6. A 4-H member who is physically incapable (due to injury or illness) of showing their animal:
 - Showmanship- the 4-H member must be available to answer questions from the judge.
 - In this instance, with the approval of the Extension Educator or 4-H Assistant, a parent/leader can help.
7. A visibly ill or unsound animal may be dismissed from participation by show personnel or at the judge's discretion.
8. Horses may not be ridden double at any time.
9. Horses may not be ridden with halters only.
10. If riding bareback at any time on the fairground, a helmet is required.
11. The arena is off-limits to everyone except working show personnel or during an emergency. Only officials and the exhibitors may enter the show arena.
12. No riding after dusk except for official classes or unless the arena is properly lit.
13. Any running of horses at the Elmore County Fair will be grounds for disqualification from the show. Horses will not be ridden in the parking area except when going directly to the show arena. Any 4-H Leader or Official may enforce these rules and relay the information to the show committee.
14. All livestock shall remain in designated areas as posted. Horses will not be allowed in other livestock or camping areas except for the Round Robin Competition.
15. Vehicles, campers, or trailers parked in the stall area will only be parked in the authorized areas. Vehicles, campers, or trailers parked in prohibited areas will be towed away at the expense of the owner.
16. For privacy reasons, members overall scores will only be given to the individual members.

17. Judges' decisions are final. Only Chairmen are allowed to address the judge about classes/placing during the show. If parents or leaders have concerns, they need to address their concerns respectfully with the horse chairman.
 - Judges have been carefully selected and approved by the Elmore County 4-H Horse Working Group, the Elmore County Extension Educator, and the 4-H Program Assistant.
18. Members may choose which project horse they will show in Showmanship at the Elmore County Fair to complete their project. However, the showmanship horse must show in at least one other class. 4-H members may show English or Western.
19. Members doing WRH only must also participate in at least 2 other horse show classes besides showmanship and trail.
20. The project leader shall decide the eligibility of members to compete unless specified otherwise in a certain area. For example: WRH or Jumping.

Approaching the Judge

- It is the show committee's responsibility to provide an opportunity for exhibitors to approach the judges.
 - This information will be relayed to exhibitors during the informational meetings or by other means.
 - Before the beginning of a class or show, questions about specific classes or rules need to be addressed to all exhibitors, not one to one.
 - Show committees need to remember that judges' decisions are final.

Exhibitor:

- While the judge's decision is final, every exhibitor should have an opportunity to approach the judge to ask questions.
 - This should be for educational purposes only, not to dispute places.
 - The exhibitor should not approach the judge until after the final class of the day or as otherwise specified by the show committee.
 - A parent or leader may be present.
 - The contestant should provide their exhibitor number and any score sheets they may have received, but photos or videos are not allowed.
 - The contestant should expect discussion or explanation on how to improve.

Judge:

- The judge should confirm with the show committee or superintendent when questions may be asked and answered and when an exhibitor may approach the judge.
 - A show committee has the recourse to not rehire a judge who has not met their expectations.
 - Concerns regarding judges who do not meet 4-H standards can be addressed to the PNW judges' list coordinator and the PNW judges' review committee. Evaluation forms are available on the web.

- The coordinator and committee will investigate any concerns and make an appropriate response to the judge.

PROJECT COMPLETION REQUIREMENTS

1. Members must participate in obtaining at **least one (1) \$35 sponsor**. If a member is participating in Working Ranch Horse and/or Mini they must obtain an additional \$35 sponsor.
2. Members must attend a minimum of **10 club meetings** of which at least 6 of them must be riding meetings. Working Ranch Horse members must attend 6 Working Ranch Riding meetings. Due to working with cattle and roping, other meetings will not count for WRH.
 - **If a parent is also a leader, a member must have at least 3 of the 6 required riding meetings with a club.**
 - A member must have all 4 business/book meetings with a club or horse working group.
3. Mini members must have 6 practice/working with mini horse meetings and 4 book meetings.
4. All members are required to TURN IN a completed portfolio which includes a completed record book.
5. Each member must participate in a 4-H planned community service project.
6. **All members must declare all 4-H horses they work with, in the animal section of ZSuite including uploaded pictures by the 4th Friday of April.**
7. Members must declare the final horses that they will be using at the fair when they complete their fair registration in June and will only need records on those final horses in their record book.
 - All members must meet with the group leader to present animals for evaluation.
8. Each 4-H member is encouraged to attend the Horse Educational Clinic which will be provided by the Horse Working Group.
 - 1st year members are required to attend the horse educational clinic or other event prior to fair.
9. Members doing WRH only must also participate in at least 2 other horse show classes besides showmanship and show trail.
10. The project leaders shall decide the eligibility of members to compete unless specified otherwise in a certain area. For Example: WRH or Jumping.

DRESS CODE

All 4-H members participating in any Elmore County 4-H equestrian activity must wear an approved helmet whenever they are mounted on an equine or are in a vehicle (cart, wagon, buggy, etc.) being pulled by an equine.

- This includes riding meetings, trail rides, play days, shows, etc.
- The helmet must be properly fitted with the harness engaged and properly fitted.
 - An approved helmet meets the minimum performance standards imposed by the American Society for Testing Materials (ASTM) F1163 and includes certification and labeling required by the Safety Equipment Institute (SEI). The most common standard used by sanctioning

organizations in the United States is known as ASTM F1163[10] It is periodically updated, the most recent is ASTM F1163-13 (2013).[11] It is a performance standard written by a volunteer committee of producers (persons who represent manufacturing companies) and users of equestrian helmets and published by ASTM International. The standard defines performance criteria and test methods; it does not prescribe helmet design. This is the current standard adopted by the American National Standards Institute (ANSI)

- Members should be neat, clean, and dressed in long sleeved shirts and long pants.
- An exhibitor's hair must be worn in a net, braid(s), or other means to present a neat appearance and give the judge a clear view of the show number.
- Boots are required for exhibitors in all classes INCLUDING mini horse exhibitors (attendants may wear hard-soled shoes.)
 - Boots are defined as high-topped (above the ankle) leather or leather like riding shoes with heels.
 - The boot must have an adequate heel to prevent it from moving forward through the stirrup. Exhibitors must be able to move the boot freely in the stirrup and easily slide the boot out of the stirrup.

This includes Mini members except for the helmet, a cowboy hat maybe worn instead of helmet.

Western clothing and equipment are appropriate in western classes including, but not limited to trail, western equitation, showmanship, ground training, driving, bareback.

Required:

- Long sleeved western shirt with collar, tucked in and sleeves rolled down.
- Jeans, trousers, or western pants.
- Belt, unless loops are not present or are covered by another garment.
- Western boots
 - High traction soles and fat baby boots are discouraged, especially in Working Ranch Horse classes.
- ASTM/SEI equestrian approved helmet (optional in showmanship).

Optional:

- Vest, jacket, coat, sweater, and/or jacket with collar
- Gloves
- Ties, pins
- Chaps are optional in all classes except showmanship
- Spurs- must be dull and rowels free moving

Not allowed

- Chaps in showmanship
- Whips or crops, except in driving, western games
- Spurs in showmanship, driving, ground training, and in-hand trail

AWARDS

4-H uses the Danish system of awards in which every contestant receives a ribbon. Trophies, rosettes, and other special recognition may be awarded in addition.

The standard breakdown for ribbons is blue award: 85-100, red award: 70-84, white award: 69 and below. Disqualified riders will receive a white ribbon. The system may also be modified in classes that do not follow the same 100-point system or scoring criteria.

The judges will place contestants in one of four ribbon placing groups based on how well their performance compared to that of an ideal performance. The ribbon groups and their significance are:

- **Grand or Reserve Champion-** will receive a purple or pink ribbon
- **Purple/Pink-** An outstanding performance that met all the class requirements. Contained few if any flaws. **MEMBER MUST HAVE RECEIVED A BLUE RIBBON TO BE ELIGIBLE TO RECIEVE GRAND OR RESERVE.**
- **Blue-** A very good performance that met all the class requirements. The performance contained few flaws but was well above the minimum standards.
- **Red-** A good performance that met all the class requirements. The performance was slightly above or at minimum standards. Although displaying good effort, the performance contained several flaws.
- **White-** An average performance that met the minimum requirements of the class. The performance contained several flaws and considerable room for improvement exists.
- Where there is but one exhibit in a class, the award shall be made on merit alone.
- Record book ribbons must remain with the books until checkout on Sunday.
- **Only awards listed in this rule book (see below) are to be awarded. No additional awards may be added.**

5 & 10 year 4-H Horse Program participation buckles for any completed horse project member.

Participation Awards:

Participation awards will be for new members only. Juniors must show in at least 5 classes at the fair. Intermediates must show in at least 6 classes at the fair. Seniors must show in at least 7 classes at the fair. Working Ranch Versatility classes will count as a total of 1.

Overall Awards: All Overall Divisions will use the same point system.

To be eligible for awards, members must have obtained their sponsors. High Point awards will be determined in the Fair Office with the 4-H Assistant.

Elmore County 4-H Horse Overall Points For All						
Number of Exhibitors	1st Pl.	2nd Pl.	3rd Pl.	4th Pl.	5th Pl.	6-20th+ Place
1	1					
2	2	1				
3	3	2	1			
4	4	3	2	1		
5	5	4	3	2	1	
6-20+	6	5	4	3	2	1

High Point Awards:

- **English High Point** will be awarded to the horse member who obtains the highest number of accumulated points in English Pleasure and Equitation. English Green Horse class is not included. In the event of a tie, record book scores will be the tie breaker.
- **Western High Point** will be awarded to the horse member who obtains the highest number of accumulated points in Western Pleasure, Western Horsemanship, and Reining. Green Horse class is not included. In the event of a tie, record book scores will be the tie breaker.
- **Walk Trot Limited Rider High Point** will be awarded to the horse member who obtains the highest number of accumulated points in all discipline walk trot limited rider high point classes. In the event of a tie, record book scores will be the tie breaker.
- **Green Horse High Point** will be awarded to the horse member who obtains the highest number of accumulated points in all disciplines. In the event of a tie, record book score will be the tie breaker.

Mini Horse Awards:

- **Mini Showmanship-** Grand and Reserve may be given in each age division. Overall Showmanship WILL consist of the Grand and Reserve winners of each age division, with an overall Grand and Reserve Showmanship award given. Overall showmanship winners are eligible for the large animal Round Robin.
- **Mini High Point** - includes the following classes: Trail, Jumps, Key Hole, and Barrels.
- **Working Ranch Horse Top Hand- Grand in each division.** The member who obtains the highest number of accumulated points in all 6 classes. Green horse class will not be eligible unless it is the member's only horse. In the event of a tie, record book scores will be the tie breaker.

SHOW PROTOCOL

1. Members should be courteous and alert and follow instructions given by the judge or ring steward, including entering promptly when a class is called.
2. Attitude is scored. Exhibitors should show confidence and pride in themselves and their animals. They should be good sports. Contestants are judged at all times when in the ring.
3. Show management or the judge reserves the right to dismiss any youth or party from any 4-H class or show for any misconduct, lack of sportsmanship, or infractions of the rules. Exhibitors may forfeit awards received in the class or at the show.
4. Any parent or leader will be asked to leave for his/her unsportsmanlike behavior or failure to comply with fair and 4-H rules. If there are problems, the Fair Board will be contacted, and the individuals will be escorted off the fairgrounds. If there are further problems, the police will be called.
5. **Disrespect shown to any judge or fair official will result in forfeit of all awards made to the offending exhibitor and that person will be asked to leave the grounds. Disrespect show to any**

judge or fair official by parents/leaders will result in being asked to leave the fairgrounds. If there are problems, the Fair Board will escort the individuals off the fairgrounds. If problems persist, the police will be called.

6. The use of cell phones or other electronic devices are not allowed in any show. If a member uses a cell phone or other electronic device in any show, it will be considered an infraction of the dress code and left up to the discretion of the judge in placing.
7. Contestant numbers must be clearly visible either on the rider's back or on both sides of the saddle pad. (The exhibitor is responsible for supplying the second number.)
8. Exhibitors will be expected to approach the gate attendant for check in and will then be directed to line up.
 - No class shall enter the arena until all exhibitors have been checked in or scratched from the class.
 - Once a class has started no late exhibitions will be allowed to enter the arena.
9. "Gate Holds" (Delay of Class)
 - Necessary for equipment change or another species weigh in, this must be requested before the class is called to enter the arena.
 - At that time the class will be held and will not enter the area. A set time period to be determined by the Horse Working Group Chairman (suggested 15 min) will be allowed for these specific situations to hold a class.
10. Foals are to remain in the stable area, except when in a mare and foal class.
11. Any horse that is prone to kick must have a visible red ribbon attached to the top of the tail and horses that bite will have a red ribbon on their forelock.
12. Equitation classes are judged on the skill of the rider. The horse is not judged on conformation.
13. When a judge requests a movement to the right (off-side) or left (near-side), this is to the horse's right or left.
14. Exhibitors should not pat their horse while being judged in the ring, except during a colt or ground training class.
15. All exhibitors must maintain a proper distance of one-horse length between themselves and other exhibitors. **DO NOT CUT OFF OTHER CONTESTANTS.**
16. Special needs youth and/or anyone needing assistance will ride last (at the end of a class) so members following them will not benefit more than members who rode before them.
17. English/Western Class divisions are outlined in Chapter 7 unless number of participants justifies further class divisions or combinations, determined by Horse Show Judge and Horse Working Group Chairman.

PROJECT ANIMAL

1. Foals, ponies, miniatures, mules, donkeys, and horses are suitable for this project.
 - Horses do not need to be registered
 - Stallions older than 12 months are not allowed in 4-H contests or events
 - To be classified as a pony, they must be 56 inches in height or less. When there are a great number of ponies they may be divided into small pony and large pony divisions.
 - i. Small pony- any pony less than 48 inches in height

- ii. Large pony- any pony 48-56 inches in height
 - iii. When there are few ponies, counties have the option of combining horse and pony classes.
 - 1. Mini horse/pony shall not exceed 46 inches in height for the mini horse division. Verification of the miniature horse shall be determined by measuring the vertical distance from the base of the last hairs of the mane to the ground.
 - 2. Mini horses cannot be ridden in any of the riding classes or at any time on the fairgrounds.
2. Each member may have up to 3 project horses which may be owned, shared, or leased as long as they meet the requirements, and all horses are recorded in the member's record book and were declared in April.
 - A shared project animal is defined as only immediate family members or two non-family members sharing the same horse, including care and training responsibilities. Members and parents must recognize that adjustments and/or choices may need to be made to adapt to show conditions or schedules, such as when two members are in the same class or are competing for championships.
 - A lease agreement is permissible if the member provides primary care for the horse.
 - A copy of the lease agreement must be turned into the Extension Office by April.
 - Project animals (owned, leased, or shared) must be under the care and management of the 4-H member **at least 80% of the time (5-6 days per week) which includes feeding, providing/paying for feed, health expenses, grooming, exercising, training, and access to use for at least 90 days** before the animal may be shown at the official county exhibit activity.
 - Except for hardship cases which must be petitioned before the Horse Working Group. Substitution of horses (**must be a previously declared horse**) must be approved by the Horse Working Group. Substitutions may be approved for the following:
 - i. In the event of an accident or illness, if accompanied by a veterinarian statement.
 - ii. If the horse proves to be totally unmanageable or dangerous.as
 - Once fair has started, no petition may be presented unless an injury occurs at fair. A veterinarian recheck may be required at the owner's expense. The animal may continue in the competition upon presentation of a certificate from a veterinarian stating the ability of the animal to continue.
 3. In Idaho, only the 4-H member(s) can personally train their animal 90 days prior to the county - designated event and state fair.
 4. The project horses must be vaccinated for 4 Way and Rhino within 90 days of the fair or have current (within 30 days of the fair) health certificate from a veterinarian.
 - Vaccinations must be recorded on the record of vaccinations page or health exam certification. Attach the receipt, bottle label, or health certificate.
 - Horses shall be free from any signs of infection or communicable disease.
 5. The 4-H horse program does not condone the use of drugs, herbal compounds, or surgical procedures which affects an animal's conformation, appearance, natural performance, or in any way alters its natural color.
 - Horses requiring any medication should be identified upon arrival at the 4-H Horse Show Office or registration area. Members must get leader and veterinarian approval for medications and must report the use of any drug for their horse to the

superintendent/chairman prior to the show. Failure to follow this rule may be cause for disqualification.

- If a horse requires medication or treatment after arrival at the show, any medication used to protect the health and welfare of the animal must be prescribed by a licensed veterinarian.
 - Administration of all medication must, always, be done in accordance with the specification and/or instructions given in the prescription.
 - Liability for the correct administration of the prescribed drug is the responsibility of the exhibitor's parent or legal guardian.
6. Volunteer policy or animal disease diagnosis and treatment
- 4-H volunteers, as representatives of a land-grant university, are expected to act within the policies and guidelines of the 4-H youth development program.
 - i. A 4-H animal science volunteer may educate members and their families in the normal course of their 4-H activities in the areas of animal care, production, and management.
 - ii. University volunteers are NOT to engage in activities that include the diagnosis or treatment of or the direct administration or medications to protect animals without authorization from a licensed veterinarian.
 - iii. A 4-H volunteer may exercise commonly accepted first aid skills/practices in emergency situations.
7. Horses should be clean and well-groomed.
- With the feet trimmed or shod.
 - Long hair on jaw, legs, and pasterns should be clipped.
 - Inside of ears may be clipped but exhibitor will not be penalized if not clipped.
 - Fetlocks, muzzle, and bridle path should be trimmed in accordance with breed type.
 - Mane may be roached, but foretop must be left.
 - Mane and tail must be cleaned and free of tangles.
 - Horse's tail should be properly prepared according to breed or type of horse.
 - Exhibitors may not decorate their horse with glitter, paint, or other means except in costume, free style reining, or drill team.

STABLE AREA & WASH RACK

Stable Area Rules:

Stalls:

1. Assignments shall be made by the horse chairman.
2. NO saddles, bridles, or halters on horses that are loose in the stalls.
3. Only one horse per stall; except mare with foals or mini horses.
4. Shall be cleaned at least twice a day. Must be cleaned by 10 a.m. every day. Leaders are responsible for seeing that all stalls are cleaned.
5. Shall be cleaned and all sawdust and/or straw and waste products removed no later than 2 p.m. Sunday FOLLOWING THE CLOSE OF THE FAIR.
 - a. A \$25.00 fee per stall will be charged for not cleaning pens on time.

- b. The horse working group chairman will be responsible for checking to see that stalls are clean.

Feed:

1. Horses are to be fed and given fresh water at least twice a day.
2. Hay nets shall be tied high enough to prevent a horse from getting a foot stuck in them when nets are empty.

Wash Rack Rules:

1. Do not leave horses unattended.
2. Leave the wash area clean.
3. No water fights.
4. Be courteous.
5. Make sure all the water is off when you leave.

IF YOU DO NOT COMPLY WITH THESE RULES, YOU WILL BE ASKED TO REMOVE YOUR HORSE FROM THE STABLES.

Tack

Western Saddle & Pad

Required:

- Any standard western saddle with a horn may be used, but it must fit the rider and the horse.
- Any clean saddle pad, blanket, or combination is allowed if it provides sufficient padding for horse and rider.
- If the cinch pin or tongue on the cinch is not being used, it must be removed.

Optional:

- If a back cinch is used, it should be adjusted close to the horse and attached to the front cinch with a connecting strap.

Not Allowed:

- Australian Saddles
- Tapaderos (Stirrup covers)

Western Bridle and Bit:

- Horses 5 years old or younger may be ridden in a snaffle or bosal.
- For horses 6 years or older, a curb bit is highly preferred.
- Members showing horses 6 years or older in a snaffle must have a significantly better performance in order to be placed above a member showing a 6 year or older horse in a curb bit or bosal.
- For horses 6 years or older being shown in a snaffle or bosal will be ineligible to advance to district 4-H competitions.

Required

- Any western bridle including snaffles and bosals is allowed.
- Most types of Western bits are acceptable.
- A snaffle must have a curb strap, curb chain, or bit guards.
- Overall bit length, as measured in the picture below, can be no longer than 8 1/2 inches.



from
rein

8/12"

- The correct measure of overall bit length is a vertical line the upper-most part of headstall slot to the center of the ring.

- Curb straps must be plain leather or chains at least 1/2 inch wide and must lie flat against the jaw.
 - Leather chin/curb straps are recommended for working ranch horse classes.
 - Throat latches on all bridles are strongly recommended for safety purposes.

Not allowed:

- Sidepulls in performance classes.
- Cavessons or nosebands in performance classes.
- Mechanical hackamores, double wire snaffles, slip, or gag bits. Overall bit length, as measured in picture above, can be no longer than 8 1/2 inches.
- Rolled leather straps

Reins:

- Only spilt or romal reins are allowed in western equitation, trail, and bareback.
- Only one hand may be used for reining when using a Western bit with shanks for Western Equitation, Trail, and Bareback. The rein hand cannot be changed.
- No single reins (example: roping or barrel reins) allowed except mecate style on bosal hackamore or snaffle bit. **Exception: intermediate and advanced divisions of working ranch horse will be allowed to use rope reins while roping.** Mecate (muh-caw-tee or McCarty) reins are made from horsehair but can also be made from nylon double brain marine rope. These reins are normally between 20-22 feet long and approximately 8-10 feet are used for the rein and the remaining 10-12 feet is used as lead rope.
- When romal reins (a type of long quirt attached to the end of a set of closed reins that are connected to the bridle) are used, no finger between the reins is allowed. In these cases, the romal goes on the opposite side from the rein hand.
 - The rider's hand shall be closed around the reins with the wrist kept straight and relaxed, the thumb on top.
 - Only one hand may be used on the reins.
- The non-rein hand is not allowed, at any time, to touch the reins.



- The rider is allowed to shorten the reins while the horse is in motion as long as their hands are held in a legal manner.
- Romal reins are recommended for Working Ranch Horse classes unless showing in a snaffle bit or bosal.
- To mount with romal reins, double the end in the left hand. After mounting, slide the bight under the rein hand to the opposite side.
- For a brief dismount, romal reins need not to be taken down; the romal part may be looped behind the horn
- There are two ways to hold Split Reins
 - With the palm of the hand facing down and one finger between the reins. The free end of the rein (bight) in the opposite hand.
 - With the palm of the hand facing down and one finger between the reins. The free end of the rein (bight) falls on the same side as the “rein hand.”
 - Only one hand may be used on reins.
 - For dismounting with spit reins, both split reins, or the near rein only, may be taken down. Never let go of the reins.



- When a bosal or snaffle bit is used, two hands must be used.
 - Split reins should be held by crossing the reins between hands so that both hands are holding both reins.
 - Closed reins are allowed with a bosal. Mecate reins can be half-hitched around the horn or

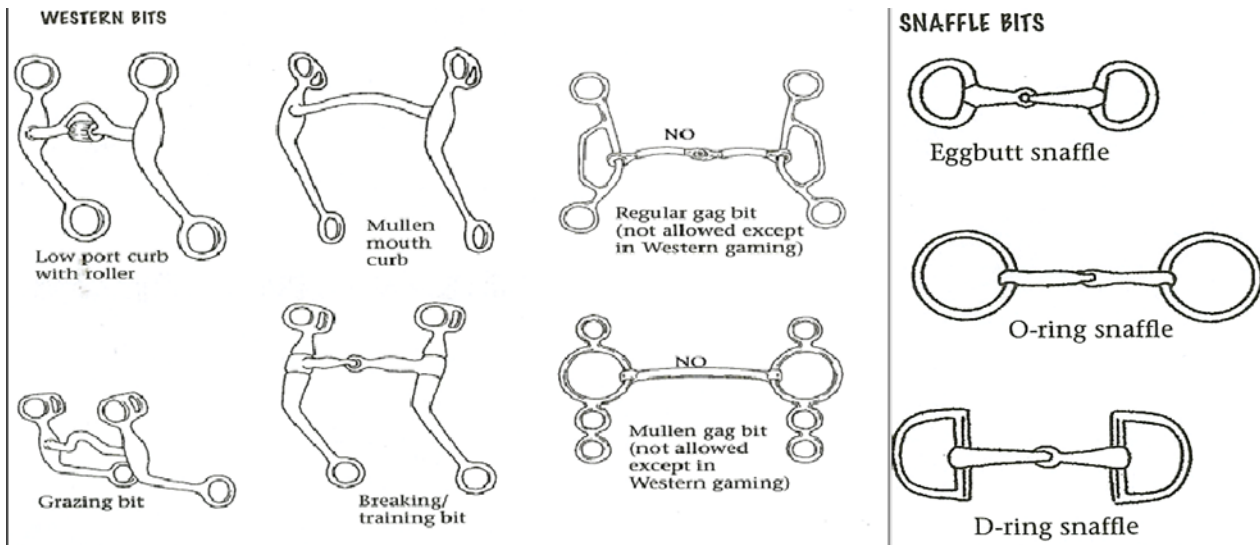

properly tucked under (not tied to) the belt.

Optional Tack & Equipment

- purs (if

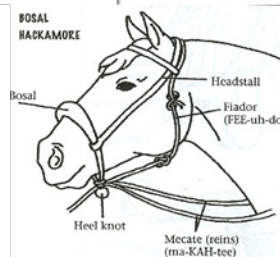

used) must be Western type and must be used properly.

- Hobbles
- Lariat or riata
- Breast collars
- Hoof boots may be used in place of shoes if they are fitted properly. They are not allowed in Western gaming.

Not allowed:

- Tie-Downs, martingales, draw-reins.
- Nosebands
- Tack collars
- Splint boots, bell boots, bandages, and polo wraps are not allowed in western equitation, trail, showmanship, or medals classes. They are allowed in western gaming, ground training, and in-hand trail.

Hunt Seat

Hunt seat or dressage equipment and clothing may be used appropriately in showmanship, driving, hunt seat equitation, equitation over fences, trail, ground training, dressage, and bareback.

Attire:

- **Required**
 - Ratcatcher, long-sleeved tailored shirt closed at the neck or a turtleneck shirt. Shirts are tucked in.
 - Hunt coat if show-sleeved ratcatcher is worn.
 - Pants, breeches, or jodhpurs
 - Tall hunt boots, jodhpur boots, field boots, or paddock boots. Leather or rubber is okay.
 - ASTM/SEI equestrian-approved helmet
 - Exhibitor's hair must be worn in a net, braid(s), or other means to present a neat appearance and give the judge a clear view of the show number.
- **Optional**
 - Hunt coat (conservative colors) only if wearing a long-sleeved shirt.
 - Spurs must be English type and used appropriately. In dressage, rowels must be free to rotate.
 - Half-Chaps
 - Gloves (any traditional color is allowed)
 - Pins or ties
- **Not allowed**
 - Spurs in showmanship, driving, ground training, and in-hand trail.
 - Leg protection for the horse is only allowed in English Equitation- Over fence classes.

Saddles and Pads:

- **Required**
 - Forward seat, close contact, jumping, or dressage seat saddle.
 - Stirrup safety bars must be in the open position in any Equitation over fence class.
- **Optional**

- Saddle Pad
- **Not Allowed**
 - Saddle seat-type English saddle or Western Saddle

Bridle & Bit:

- **Required**
 - An English bridle with cavesson.
 - Snaffle, pelham, kimberwick, full double bridle, or any other English-type bit appropriate for the seat.
- **Optional**
 - Dropped, flash, and figure 8 nosebands are allowed in dressage and hunt seat equitation over fences, no other flat classes.
- **Not allowed**
 - Side pulls and bit converters
 - Double twisted wire and gag bits

Other tack and equipment:

- **Optional**
 - Breastplates or breast collars
 - Martingales and any type of boots in equitation over fences only
 - Running martingales may be used only with a snaffle bit
 - Whips or crops can be no longer than 36 inches for hunt seat
- **Not allowed**
 - Martingales in flat classes
 - Any type of boots in flat classes

Saddle Seat

Saddle seat equipment and clothing may be used appropriately in showmanship, saddle seat equitation, trail, ground training, bareback, and driving.

Attire

- **Required**
 - Long-sleeved tailored shirt or short-sleeved shirt with a coat.
 - Tie
 - Pants, or Kentucky jodhpurs
 - Jodhpur boots (short)
 - ASTM/SEI equestrian- approved helmet
- **Optional**
 - A saddle-seat suit or day coat may be worn, but it must be a conservative color and will not be given preference by the judge.
 - Spurs must be English type and in mounted classes only.
 - Whip no longer than 48 inches, including lash.

- Gloves, a four in hand or bow tie, and a pin or flower in the lapel are traditional, but not required,
- **Not allowed**
 - Spurs in showmanship, driving, ground training, and in-hand trail
 - Leg protection for the horse is only allowed in English Equitation Over Fence Classes

Saddle

- **Required**
 - Saddle seat-type saddle
- **Optional**
 - Breast collars
- **Not allowed**
 - Dressage, hunt-type, all purpose, or western saddles.

Bridle & Bits

- **Required**
 - Full double bridle (curb and bridoon), Pelham, or breed- appropriate bit
- **Not allowed**
 - Martingales or tie downs

SHOWMANSHIP

Showmanship is required to complete your project. Members with more than 1 horse will choose which horse will participate in showmanship. **Exception: members with both a big horse and mini horse must participate in each project's showmanship.**

Class Description:

The purpose of showmanship is to teach courtesy, good grooming, poises, confidence, and how to fit, train, and handle your horse. Showmanship is a demonstration of the member's ability to show the animal, in hand, to its best advantage. Conformation of the animal is not considered.

- Attire may be Western or English
- Driving attire is allowed except for skirts or dresses.
- The type of headgear for the exhibitor in showmanship is optional. ASTM/SEI helmets, although not required for showmanship, are encouraged. Either an appropriate hat or helmet must be worn.

Class Divisions:

- Junior, Intermediate, and Senior

Equipment

Western:

- **Halter**
 - You may show your horses with a safe, properly fitted halter complete with a throatlatch.

- The halter and lead should be leather, rope, or webbing.
- The lead should be 6-10 feet (about 2-3 meters) long. Be sure the lead is long enough to allow picking up a hind foot.
- **Chain**
 - For safety or control, using a chain under the chin or over the nose is permitted but not required.
 - If used, the chain must be attached and used properly.
 - A chain approximately 15-24 inches is long enough.
 - The chain may be run through the ring on the side of the halter or through the ring on the bottom, then over the nose or under the chin to the other side.
 - With a very long chain, you may run the excess up the off cheek.
 - If your chain is too long, it may be doubled back through the bottom ring and snapped back to itself.
 - In all cases, the snap should face out.
 - When leading your horse do not put your hand on the chain.
- **Not Allowed**
 - Whips and/or bats

English

- **Halter or Bridle**
 - You may show your horses with a safe, properly fitted halter or show bridle, each complete with a throatlatch.
 - You may use a bridle when it is appropriate to breed, attire, or both.
 - If you show with a double bridle, you may use either the snaffle or curb reins for leading. The other set of reins is put over the neck near the withers.
 - The halter and lead should be leather, rope, or webbing.
 - The lead should be 6-1- feet (about 2-3 meters) long. Be sure the lead is long enough to allow picking up a hind foot.
- **Chain**
 - For safety or control, using a chain under the chin or over the nose is permitted but not required.
 - If used, the chain must be attached and used properly.
 - A chain approximately 15-24 inches is long enough.
 - The chain may be run through the ring on the side of the halter or through the ring on the bottom, then over the nose or under the chin to the other side.
- **Showmanship**
 - With a very long chain you may run the excess up the off cheek.
 - If your chain is too long, it may be doubled back through the bottom ring and snapped back to itself.
 - In all cases, the snap should face out.
 - When leading your horse, do not put your hand on the chain.
- **Not Allowed**
 - Whips and/or bats

Class Routine:

Enter the arena as directed by the judge, ring steward, or announcer. Keep at least one-horse length behind the horse in front of you. If necessary, pass on the inside and return to the rail. The exhibitor should be aware of the judge's position at all times.

The member should walk ear to ear with the horse, about an arm's length from the near side. Hold the lead 8-18 inches from the halter in the right hand with the end folded in a figure 8 or flat in the left hand. Do not coil the lead or fasten it with a rubber band in a figure 8.

If instructed to line up, do so side by side leaving 6-8 feet between horses if possible. This allows the judge to pass safely between horses and have a good view of your horse. Quickly stand the horse square, balanced, or stretched, consistent with the breed and your attire. While in line, do not let your horse circle you. Always turn the horse away from you for turns 90 degrees or more (quarter turn.)

If asked to move to another position in line, back out quietly and promptly lead to the new place. Speak to the animal to prevent it from becoming startled when another horse is moved nearby.

Pose (set up) your horse with all four feet square or according to breed type.

- Quarter type-feet squarely under horse.
- Saddle Seat types (Paso Fino, Tennessee Walker, etc.)- hind feet stretched.
- Hunter types (Thoroughbred, Standardbred, Arabian)- front feet square and under hind feet may be slightly off set (one foot more forward.)
- Draft types (Any horse that is cross bred from a draft that exhibits the physical characteristics of a draft breed will be considered a draft type)- feet squarely under the horse, one hind foot may be cocked or resting.
- When posing your horse, stand toward the front of the horse, always in position where you can see the judge and the judge can see you. Refer to the quartering system below.
- The horse's head should be up, and its weight should be on all four feet.
- Do not let the horse "go to sleep," but do not do anything that will attract attention.
- A gelding may "let down" when standing relaxed; correct by moving him forward or back.
- You should not use your feet to touch the horse's hooves to get in to set up, nor should you change hands on the lead to set up. If the horse moves out of position, quickly reset it. Quiet voice commands may be used.
- Recognize and quickly correct faults of the horse.
- When the judge is observing other animals, let your horse stand if posed reasonably well.
- The member will keep showing from the time they enter the class until the entire class has been placed and has been excused from the ring unless otherwise instructed by the judge. If the exhibitors are instructed to stand at ease by the judge, it will be announced.
- Be natural. Over-showing, undue fussing, and maneuvering are objectionable.

When the horse is set up, the exhibitor should face the horse diagonally at the 45-degree angle off the horse's shoulder in front and to the side of the head, moving from side to side, as necessary. Be in a position to see your horse and keep eye contact with the judge without blocking the judge's view or standing directly in front of your horse.

Quartering System

When the judge inspects your horse, respond to his or her movements with the quartering system.

- Mentally divide the horse into four quarters
- When the judge is in the right front quarter, you are on the left quarter of the horse, keeping an eye on the judge.
- When the judge is in the back-right quarter, you are in the front right quarter watching the horse.
- The objective is for you to be in the quarter next to the judge's position.
- Change sides when the judge is at the heart girth and when the judge crosses the tail and nose.
- You should step around the horse's head quickly and quietly when changing quarters, using three or four steps, and keeping eye contact with the judge.
- Do not change hands on the lead when you change sides, and never stand in front of your horse in the "danger zone."
- Handler remains in quarter #1 and #2 at the horse's head. Handler should always be in the quarter that is adjacent to the judge's position. This enables the judge and handler to always see each other. Listen carefully to instructions. When asked for your individual performance, follow the judge's instructions.
 - Be ready to move promptly when signaled.
 - Lines should be straight, and you should remain 5-7 feet away from the judge.
 - Haunch turns and forehand turns should have forward motion.

Mini Showmanship

The half system will be used in exhibiting your horse in showmanship.

Exhibitor must be on the opposite half of the horse from the Judge. When the judge is in position 1, the exhibitor should be in position 1. When the judge is position 2, then the exhibitor should be in position 2, etc.

A western hat or helmet must be worn in showmanship. Optional for other classes.

Mini Showmanship Patterns:

- Three showmanship patterns for each age division are in the back of this rulebook.
- One pattern from each age group will be selected for use at the show at fair.

Judging Criteria & Judging Requirements:

- Horses should be well-groomed, clean, and clipped according to the breed. The horse should also be well-trained to the required routine and well-mannered so that it stands quietly, but alertly, while in the class.

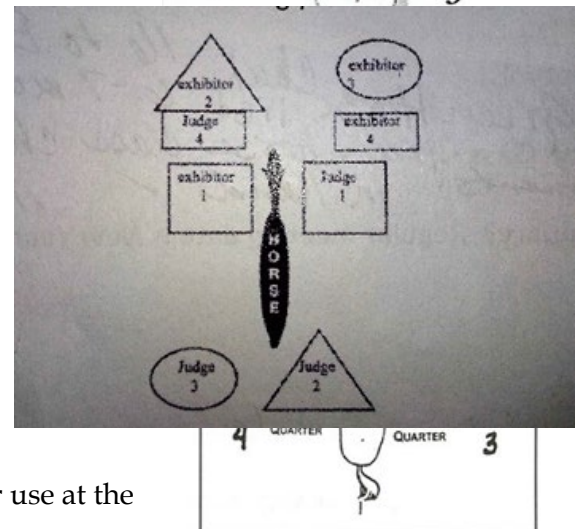
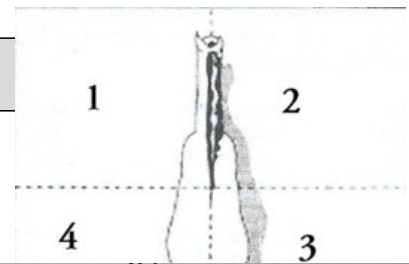

- The exhibitor will be asked to demonstrate their ability to lead, turn, set up, and move their animals as the judge requests. Additional tests, as listed may be asked.

Showmanship Principles:

The following principles always apply:

- Individual tests must be performed with official(s) involved in the same relative position to each exhibitor.
- The exhibitor shall not stand directly in front of the horse.
- The quartering system is required.
- Horses are to be shown, trimmed, and groomed according to breed type.
- The exhibitor shall not touch their horse except when executing a requested test that allows such touch (Ex: Side pass and turn on the forehand) or to smooth the mane or forelock if the judge's inspection has disturbed the grooming. (Tails do not need to be smoothed.)

Tests:

- Back horse. To back, face to the rear of the horse. Do not change hands on the lead to back. Back the horse the requested distance in a straight line. Four steps are considered one length, counting the movement of the front feet. If the pattern includes "closing the back," return to your position at the start of the back and balance your horse.
- Side pass. The exhibitor may touch the horse.
- Turn on haunches (needs forward motion)
- Turn on the forehand (needs forward motion.) The exhibitor may touch the horse.
- Lead at the walk or trot from either side.
- Pick up the feet.
- Stop and set up, square and balanced, or according to breed standard. Do not change hands to set up.
- Answer questions from project materials.
- Perform a circle at a walk or trot.

Scoring: 100 points total

- **Member = 25%**
 - Neat and clean, properly dressed, prompt and alert, confident (poised), and courteous.
- **Animal and Equipment = 25%**
 - Animal clean and brushed, in good condition, feet card for. Halter and lead fitted, equipment clean and safe.
- **Showing the animal = 50%**
 - Following directions, leading, turning, standing, backing, stopping, showing to advantage, controlling on lead and in line, and attention in line.

Overall Showmanship:

All Grand and Reserve Showmanship winners from each class division from big horse will be competing together, and all Grand and Reserve Showmanship winners from each class division from mini horse will be competing together.

The class will consist of a pattern and rail work and will escalate in difficulty to distinguish the overall showmanship winner. The class will be judged on the quartering system above.

Maneuvers may include but are not limited to walk, trot, stop, back, pivot of various degrees, forehand pivot, haunch pivot, quartering system, inward turn, and knowledge, etc.

Overall Grand and Reserve Showman from big horse and mini horse will be able to advance to the Round Robin Showmanship.

MARE & FOAL

Members must complete all the Elmore County 4-H Horse requirements in addition to the Mare and Foul skills checklist.

To minimize stress in this class there will be no announcing until the class is complete. This class will be held 1st before every other class to keep all other horses away from the mare and foal projects. At least 2-3 horse lengths must always be kept between each pair. If an exhibitor is using their foal for other classes (in hand trail) they must be allowed to show 1st and return to the barn before other exhibitors line up.

Mare and Foal Class Description:

This is a breeding project class. What the exhibitor produces is what they are showing. The emphasis of the class will be held on the handle ability of the foal. Quality of mare and foal with the exhibitor's knowledge of their project counts towards the final score. The mare and foal must be present in the ring at the time of judging. The exhibitor must select another Elmore County 4-H member to lead the mare in the class.

Judging Criteria:

The exhibitor will be asked to lead their foal through a series of obstacles to include, but not limited to walk through poles and cones, walk in a straight or curved line, back three steps, trot in a straight or curved line, stand quiet for judge's inspection, and demonstrating proper technique for safely picking up a front foot. The mare will be required to stand to the side while the foal is negotiating obstacles. Exhibitors must maintain proper position while leading the foal at all requested gaits. Judge may ask the exhibitor any question about their project such as the foals date, bloodlines, intended use, current events that effect horse breeders, and what the exhibitor likes and dislikes about their foal. Mares' overall appearance will be judged as a part of the quality of the mare's score. Mares should be healthy, clean, and easy to handle.

Scoring:

Handle ability of the foal	40%
Quality of foal	20% (Judged on the breed standards)
Quality of mare	20% (Judged on the breed standards)
Member's knowledge of foal	20%

MINI IN HAND JUMPS

There will be a minimum of six jumps and a maximum of 8 jumps. Course diagrams must show with arrows the direction each obstacle must be taken and markers or a line must indicate the start and finish of the course.

1. The minimum age for a horse to enter jumper is 3 years old.
2. The exhibitor MAY NOT go over the jumps with the horse.
3. Whips are not permitted in the show ring.
4. Front leg wraps and/or boots are optional.
5. Baiting of horses to encourage them to perform any of the jumps is not allowed.

Circling once upon entering the ring and once upon leaving is permissible but not after crossing the starting line.

Score sheet will be used for scoring.

The following will result in a 0 score with a white ribbon:

- Falling of the horse and/or exhibitor
- Three cumulative refusals
- Off course
- Baiting of horse

All ties will have a jump-off held over the original course. The heights of the jumps shall be increased not less than one inch and not more than six inches in height. The jump-off will be timed by a stopwatch and the horse that has the fastest time and the fewest faults in the jump off round will be declared the winner. An elimination in a jump-off does not eliminate the horse from final placing.

Jumps:

All jumps used in performance classes must be collapsible. There will be a minimum of four fences and a maximum of six fences. Jump height will be staggered/varied.

- The fences can range in height from twelve to twenty-four inches.
- All jumps must be at least five feet in width, no wider than six feet, with a minimum of 18 feet between jumps except for an in and out.
- All post and rail jumps must have a ground pole.
- Jump standards may not be higher than 48 inches.
- In and out jump is scored as 2 jumps. Refusal of one element of an in and out requires retaking of both elements. The distance between the two jumps is an in and out should be 10-12 feet. In and out should never be the first jump in a class.

Class Divisions:

Junior, Intermediate, and Senior

IN-HAND TRAIL

Class Description:

This class is an in-hand test of horse control and of the handler's ability to guide the horse safely through a series of obstacles.

- Open to any age horse/breed as long as it is not ridden at fair or on the fairgrounds and cannot be shown in any other riding class.

Attire:

Exhibitor may show in either western or English attire. **Spurs may not be worn. Chaps are not allowed.**

Tack & Equipment:

A halter with a throatlatch and a lead line, suitable for the horse, are required. Bridles are not allowed. A correctly attached chain may be used but it must be used properly. (See showmanship equipment.) Whips/crops are not allowed. Boots and/or bandages on the horse are allowed.

Class Routine:

A course is considered set once a horse has started the course. There must be no changes made of obstacles or courses, after that time. The course must be the same for all exhibitors once the class has started unless exclusion is given for a particular class.

Class Divisions:

Junior, Intermediate, and Senior

Course:

The course will be designed so that exhibitors can move quickly and smoothly between obstacles.

- The course should contain 6-10 obstacles and should be designed to be completed in less than 5 minutes.
- Care should be taken so that there is not an advantage to either a large or a small horse. The course should be designed to be suitable for all breeds and sizes.

Obstacles (Mini):

Course may consist of any combination of the following:

1. Bridge
2. Tarp- horse walks over
3. Walk over poles
4. Backing L Shape- Horse starts to back up. Initially, the handler entered the L with the horse, as the horse reached the turn, the handler stepped to the outside of the poles and guided the horse around the corner, then reentered the L and finished backing the horse out of the obstacle.
5. Walk under a canopy or pole with strings
6. Gate
7. Pick up an object/bucket full of items, then carry it from point A to point B. Exhibitors will then set the object/bucket full of items down.
8. Place a saddle pad or blanket on the back
9. 4 corners
10. Side pass

11. Ground tie- Horse stands with front feet inside a circle outlined in chalk. The exhibitor will drop the lead rope, walk to a designated spot, watch the judge for signal to continue, then the exhibitor will pick up the lead rope and continue pattern.
12. Mailbox
13. Trot around poles/cones

When deciding if the handler should go over obstacles with the horse or work inside poles/boxes, etc. Safety should be the primary consideration. This could depend on the size of the horse and the size of the obstacle. The handler must stay out of the danger zone. If there is a definite preference for how an obstacle should be completed, this should be clearly stated in the pattern.

In Hand Trail Basis of Judging:

The judge will consider the difficulty of the obstacle as part of the score. Emphasis is placed on safety, the horse's manners and response to the handler, and the quality of the movement. The exhibitor should be poised, confident, and courteous and should display safe and quiet techniques in handling the horse. Handlers may be asked to move on at the judge's discretion or after three refusals.

Disqualifications:

- Horse gets loose.
- Extreme disobedience.

MINI HORSE IN HAND POLES, IN HAND BARRELS

Mini In Hand Poles:

Six poles set in a straight line, each spaced 9 feet apart (measured middle of pole to middle of pole). With the start-finish line 10 feet from the entrance gate and 9 feet in front of the first pole. The exhibitor crosses the start line, travels to pole number 6, bends back through the poles, turns, bends through the poles to number 1, turns and travels across the finish line.

There is a five second penalty for each pole knocked over.

Class Divisions:

Junior, Intermediate, and Senior

In Hand Barrels:

Barrels are fun and competitive sports that stimulate excitement and a higher activity level amongst 4-H youth. Even though they are timed events, emphasis is on safety. Barrel spacing will be 15 feet across and 20 feet down to point. Start/finish line is 15 feet from barrels and must be at least 10 feet from the gate entrance.

- The contestant is allowed a running start from inside the arena and must come to a complete stop before exiting the arena.
- Timing will begin as soon as the horse's nose reaches the starting line and will be stopped when the horse's nose passes over the finish line.
- Knocking over a barrel carries a five second penalty per barrel.

Ribbon Placement for barrels and pole bending:

- Junior and Intermediate
 - Blue: Less than 27 seconds
 - Red: 27-36 seconds
 - White: Over 26 seconds
- Senior
 - Blue: Less than 24 seconds
 - Red: 24-34 seconds
 - White: Over 35 seconds

MINI HORSE KEYHOLE-INHAND

In-hand Keyhole:

- Keyhole will be marked according to diagram.
- Competitors must turn their horse away from them.
- Handler and mini at starting signal, crosses the start line, races into the keyhole, turns horse and returns across the start line.
- Judge must be at the keyhole to decide upon disqualification- their decision is final.
- Stepping on or over any of the lines of the keyhole will result in a 1-point deduction.

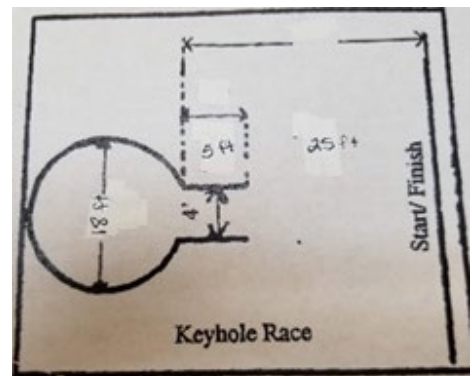

Class Divisions:

Junior, Intermediate, and Senior.

Ribbon Placings for All Ages:

- Blue: Less than 7.0 seconds
- Red: 7.01 - 10.00 seconds
- White: Over 10.00 seconds

ENGLISH DISCIPLINED RAIL

Class Description:

This class is to show the ability of a highly trained equine. At all times, the safety of the horses and exhibitors are to be the first concern.

Class Division:

Junior, Intermediate, and Seniors. (Exception- No Green Horse or walk/trot.)

Class Routine:

The class routine shall be to perform work on the rail, and may include, but is not limited to:

- A short walk, jog, or slow lope.
- A hand gallop (no more than eight horses at a time, twice around the ring.)
- Starting into a lope from a halt.
- Starting and traveling on the incorrect lead.
- Side pass both away from the rail (at least five steps) and then back to the rail.
- Turn on the forehand and turn on the hind quarter. (Once each way.)
- Stop and stand quietly on a loose rein.

Judge may ask for a reverse at the jog but not at the lope. Judge may ask for additional safe work.

Judging Criteria:

Judge shall work the entries adequately but must not overwork them. This is not a game of fault and out class and shall not be judged on an elimination basis. Final judgement shall be based on the best overall disciplined rail performance including responsiveness, manners, and quality of movements. At all times, the safety of the horses and exhibitors are to be the first concern.

Scoring:

To be judged on performance, smoothness, obedience, and consistency.

ENGLISH EQUITATION

The horse should do what the rider asks with the least possible effort on the part of the rider and least amount of resistance from the horse.

Gaited horses that pace, slow gait, fox trot, single-foot, rack, or perform a running walk may be worked with the class adjusting their speed to conform to the other horses. When riders are asked to post the trot on the rail or in a pattern, the intermediate gait is acceptable if that is breed standard.

However, if all other aspects of the performance are equal, a rider posting correctly will be given preference.

Class Divisions:

Walk-Trot, Junior, Intermediate, Senior, Green Horse Walk Trot, and Green Horse Lope.

Class Routine:

Exhibitors will enter the ring to the right in a counterclockwise direction at the walk and complete one circuit of the arena. The exhibitors will line up to complete individual pattern. Upon completion of exhibitor's pattern, they will find a place on the rail and wait for all exhibitors to complete the pattern.

Judging Criteria:

The member will be judged on correct posture, smooth gait transitions, and effective use of aids, with special emphasis on light hands. The performance of the horse is not to be considered more important than the methods used by the rider in obtaining the performance.

The member, horse, and equipment may be inspected at any time during the contest. Members using unsafe equipment may be asked to leave the ring. A rider is penalized if the loose a stirrup.

English Equitation:

Changes hands on the reins, touches any part of the saddle with their free hand or falls from the horse. Rail work can be used to break ties and possibly adjust placing.

Scoring:

100 points total.

Member appearance

Clothing, equipment, courtesy, poise..... 15%

Seat and Hands

Seat, posture, head, legs, hands, balance, distribution of weight, aids 35%

Performance

Standing, starting, walking, jogging or posting trot, figure-8 or equivalent at a lope or canter from walk, stopping, turning, backing, general control 50%

Tests:

- Regular or extended walk.
- Regular or extended jog, trot, or intermediate gait.
- Lope or canter (on the correct lead or a counter canter).
- Hand gallop for hunt seat, extended canter for saddle seat.
- Perform figure-8's, serpentine, circles, straight lines, or other specific pattern at any of the above gaits.
- Simple, interrupted, or flying lead changes.
- Ride without irons and drop and pick up irons.
- Haunch or forehand turn (need forward motion.)
- Side pass or two-track.
- Transition from any gait to halt followed by "on the buckle" or loose rein.
- Change of diagonals.
- Pick up the rein (saddle seat only and only in line.)
- Back up.
- Stand for inspection.
- Mount and dismount. (Juniors may NOT be asked to mount.)
- Balanced stops.
- Answer questions from project materials.

Project Maneuvers:

- Walk/Trot, Green Horse Walk/Trot
 - Walk, posting trot in a straight line, curved line, serpentine, circle, or figure 8. Back or halt.
- Junior, Green Horse Lope
 - Walk, posting trot or canter in a straight line, curved line, serpentine, circle, or figure 8. Back or halt.
- Intermediate
 - Walk, posting trot or canter in a straight line, curved line, serpentine, circle, figure 8, sitting trot, extended/working trot, turn on haunches or forehand, flying or simple lead changes,

side pass, drop or pick irons (can leave irons down or cross over the withers). Hand gallop, counter canter, change diagonal. Back or halt.

- Senior
 - Walk, posting trot, or canter in a straight line, curved line, serpentine, circle, figure 8, Back or halt, sitting trot, extended/working trot, turn on haunches or forehand, flying or simple lead changes, side-pass, drop or pick irons (Can leave irons down or cross over the withers). Hand gallop, counter canter, change diagonal.

Unacceptable Obstacles: Reverses at the canter or hand gallop, dismount.

BAREBACK EQUITATION (English)

Exhibitors may be asked to perform any test listed in equitation. English riders must post the trot on the correct diagonal. No mount or dismount is allowed.

Class Divisions:

Walk Trot, Junior, Intermediate, and Senior.

- In bareback equitation the rider is using either hunt seat or saddle seat without a saddle.
- The tack and attire are the same as for each equitation class (i.e. hunt seat would be the same as for regular hunt seat equitation.) Except no saddle is used.
- You must post in hunt seat and saddle seat bareback equitation.

ENGLISH PLEASURE/ HUNTER UNDER SADDLE

Class Description:

The emphasis of this class is on the horse, its way of going and ability to walk, trot, canter (except walk trot class) while on the rail and keeping a pleasurable demeanor.

Class Division:

Walk trot, Junior, Intermediate, Senior, Green Horse Walk Trot, and Green Horse Lope.

Class Routine:

- The class is to enter the ring at a posting trot, in a counterclockwise direction.
- All exhibitors will go around the ring at each of the three gates: walk, trot, and canter in both directions of the ring. (No canter for walk trot.)
- Horses are reversed to the inside (away from the rail). They may be required to reverse at the walk or trot.
- The judge may ask for an extended or working trot.
- The judge must ask that horses be backed.

The English classes will be combined in class divisions of the riders as directed by need. If more than twelve riders enter in a combined group, the class will be divided.

Judging Criteria:

Horses are to be judged on performance, ability to give a good pleasurable ride, and manners.

Scoring:

Horse’s way of going/transitions 50%
Rider’s use of aids 40%
Tack and Appointments 10%

HUNTER HACK

A horse should be at least five years old before going over jumps.

ALL jumping class exhibitors must provide a 4-H jump check list and demonstrate that they are in active training. Jumping evaluations are to be evaluated by an outside committee determined by the horse working group. This is for the safety of the horses and the riders.

Appropriate tack and attire is required for horse and rider. Leg protection for the horse is not allowed in this class.

Class Description:

This is a jumping class that is the 1st step from working on English horse on the flat to over fences. The emphasis is on the horse’s form over fences, responsiveness, and way of going, precision changing leads, and obedience when halting and backing.

This is a class with all divisions competing together with 2 divisions. **Exceptions: No green horse or walk trot. All first-year jumpers will compete first with second year and up jumpers to follow.**

- 1st year jumper
 - Jumps height will not exceed 18 inches
- 2nd years and over jumpers
 - Jumps will be set between 24 inches to 36 inches
 - Jumps will be set 24 ft to 60 ft apart allowing for a 2 to 4 12- foot strides

Class Routine:

There will be a supervised warm up jumping area outside off the arena. There will be a 5-minute warm up inside the arena after the course is set and before the poles are raised for all exhibitors to trot over poles on the ground After the poles are raised, exhibitors will be allowed 1 pre jump prior to the start of the class.

Only one exhibitor in the ring at a time. **All exhibitors will have their helmets checked for proper fit before taking any jumps by the ring steward.**

Judging Criteria:

Exhibitors will be judged on their equitation skills. Horses are judged on the above items. Faults include refusals, stopping, extra circle, ticking of the rail, and knocking the rail down. The severity of the faults is at the discretion of the judge.

Scoring:

Individual Work:

Rider ...35%

Horse ... 20%

Rail Work:

Rider ... 35% Horse ... 10%

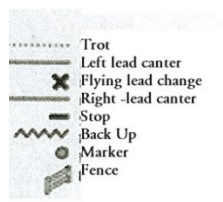

Hunter Hack:

1. Trot to first marker.
2. At marker, pick up left lead canter.
3. Cross the first jump. (Do a flying lead change as your horse jumps this fence or the next, if you desire.)
4. Canter four strides, then cross the second jump.
5. Do a flying lead change, if you haven't done so already, and canter on the right lead to the second marker.
6. Stop at marker, settle for 5-10 seconds, then exit.

OVER FENCES EQUITATION

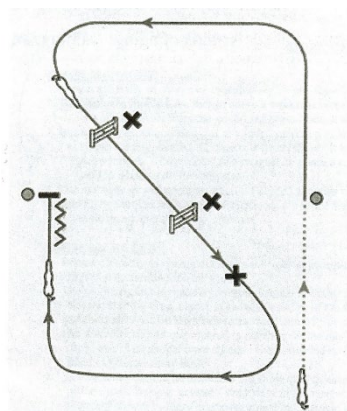

A horse should be at least five years old before going over jumps.

ALL jumping class exhibitors must provide a 4-H jump check list and demonstrate that they are in active training. Jumping evaluations are to be evaluated by an outside committee determined by the horse working group. This is for the safety of the horses and riders as safety is paramount.

Class Description:

Exhibitors may be asked to perform any test listed under equitation. Any horse that is suitable for hunter classes and capable of performing the required class routine over fences is acceptable. Of course, a horse that jumps well, smoothly, and is easily controlled makes the rider look good.

- The rider should have a workmanlike appearance, with seat and hands light and supple, conveying the impression of complete control should any emergency arise.
- Hands should rest lightly on the crest of the neck during a jump. (Distance up the neck depends on the rider's ability.) Otherwise, they should be slightly apart, over and in front of horse's withers,

making a straight line from the horse's mouth to the rider's elbow. Knuckles should be 30 degrees inside the vertical.

- Eyes should be up and shoulders back.
- Toes should be up and at an angle best suited to the rider's conformation. Ankles should be flexed, heels down, and the calf of the leg in contact with the horse and slightly behind the girth. The iron should be on the ball of the foot.
- The course will consist of 6-12 jumps performed at a canter with at least one change of direction. Courses should have at least four different types of jumps and one combination jump (24 or 36 feet apart.)
- Any test listed under equitation may be asked. Any or all exhibitors may be called back to perform at walk, trot, or canter, or to execute any appropriate tests as determined by the judge in order to place the class.

Class Division:

- 1st year jumper
 - Jump heights will not exceed 18 inches
- 2 years and over jumper
 - Jump heights will be set between 24 inches to 36 inches
 - Jump height is not to exceed 3 feet and the spread is not to exceed the height.

Class Routine:

The course will consist of 6-12 jumps, performed at a canter, with at least one change of direction. Under the direction of the judge, a safety inspection should be done before riders take any warmups or jumps.

The inspection will include but is not limited to:

- Making sure the stirrup bars are open.
- The stitching on the saddle stress points is in good repair.
- The girth is snug.
- The bridle is properly fitted and in good repair.

There will be a 5-minute warm up inside the arena after the course is set and before the poles are raised for all exhibitors to trot over poles on the ground. After the poles are raised, exhibitors will be allowed 1 pre-jump prior to the start of the class. Jump courses will not be used as practice courses at any time.

Exhibitor may circle once before the first jump of the course. Any or all exhibitors may be called back to perform at a walk, trot, or canter, or to execute any appropriate tests as determined by the judge in order to place the class.

Types of Fences:

Required:

- Spreads should not exceed the height of the fence.
- Wings at least 12 inches higher than the jumps and 30 inches wide are compulsory when jumps are less than 12 feet wide.
- The distance between standards should be a minimum of 9 feet.
- Ground pole or lines are required.

- Courses should have at least four different types of jumps and one combination jump. (24 or 36 feet apart.)

Optional:

- Basic types of fences are allowed. For example: post and rail, wall, gate, brush, coop, planks, and picket fences.

Not Allowed:

- In and outs are not to be used at the start of the course.
- Use of striped rails is discouraged.
- Triple bars, hogs, backs, targets, square oxers, hinged chicken coops, and any bizarre or dangerous jumps.

Judging Criteria:

- Performance will be judged on effective use of aids on the entire course. Emphasis will be on light hands, balance, correct posture, and seat on the flat and over fences. Excessive speed will be penalized.
- A refusal will be called when a horse avoids a jump or stops forward motion. If the refusal is a combination jump, the rider must retake all the elements of the combinations.
- Faults such as knock-downs and touches will not be considered unless they are the fault of the rider.

Scoring:

- Loss of reins- ½ fault
- Loss of stirrup - ½ fault
- Trotting while on course - ½ fault
- Touch of obstacle by horse's body behind stifle - ½ fault
- Touch of obstacle by horse's body in front of stifle - 1 fault
- Touch of standard, wing, or markers by horse or rider - 1 fault
- Knockdown of obstacle, standard, or markers - 4 faults
- First disobedience or refusal, including circling - 3 faults
- Second cumulative disobedience or runout - 6 faults
- Excessive speed/ Loss of control - 6 faults

The following will result in a 0 score with a white ribbon:

- Fall of a horse or rider
- Riding off course
- Three cumulative refusals
- Deliberately addressing or showing an obstacle to your horse

Over Fences Course 1

Over Fences Course 2

Over Poles Class:

Poles will be on the ground. This class can be completed at a trot, extended trot, or canter. Exhibitors will complete course as a jump class, rise to 2-point position and all faults will be scored as for regular over fences. Exhibitors will only be allowed to compete in regular over the fences or poles class, they will not be allowed to compete in both.

1st year jumpers or green horse lope. **No Walk Trot.**

Scoring: Rider ... 50% Horse ...40% Appointments ...10%

Three cumulative refusals will be a 0 score with a white ribbon.

TRAIL (Western or English Attire)

Class Description:

The trail class is an under-saddle mounted test of horse control and the rider's ability to guide the horse

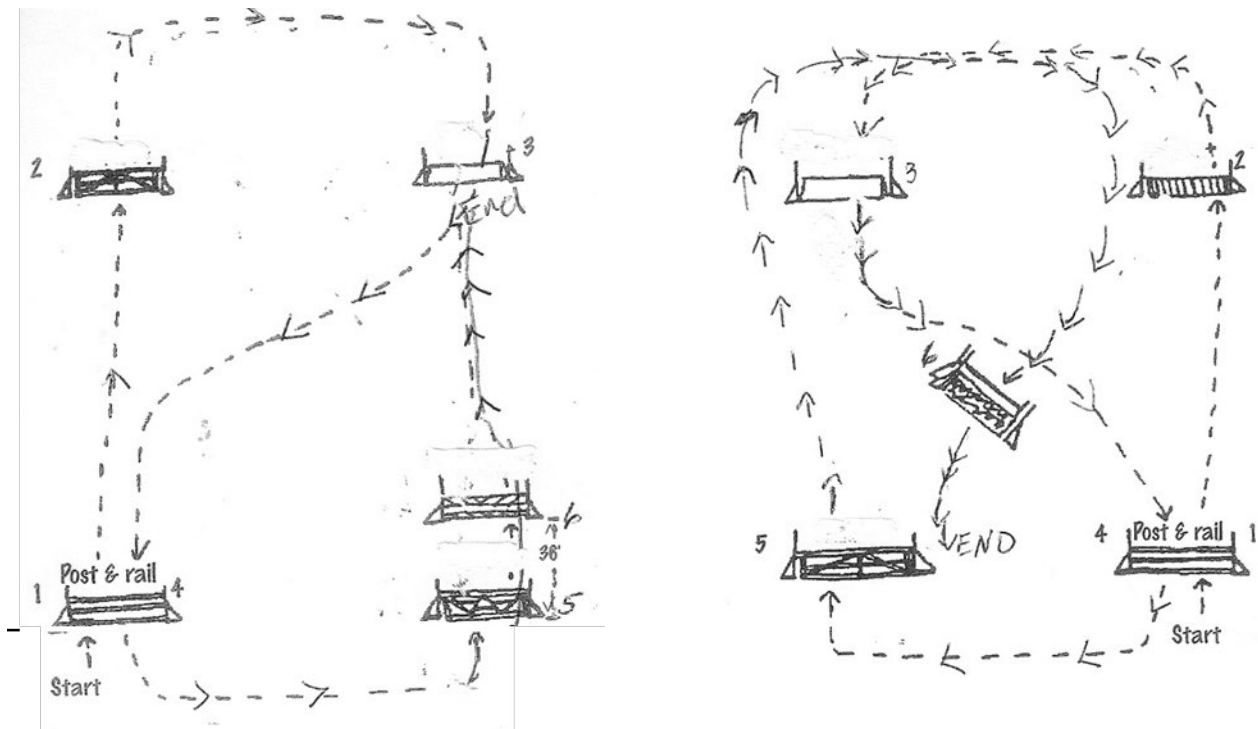

through a series of obstacles. The course must be safe for the horse and rider. The obstacles may be progressively harder for each age group.

- Courses will contain 6-10 obstacles which may be used individually or in combination. See page 57.
- The course should not be spread out over a very large area.
- Obstacles spacing must allow the horse to move easily between obstacles with no wasted time.
- The course should be designed to be completed in less than 5 minutes.
- The rider may show English or western. See clothing and equipment specifications for proper tack and attire.

Trail:

- Courses must be posted showing the order and direction of the obstacles.
- Each disturbed obstacle must be measured and reset for the next rider.
- Obstacles may be used individually or in combination.
- See table 1 for obstacles and suggested spacing.

Class Divisions:

Walk/Trot, Junior, Intermediate, Senior, Green Horse Walk/Trot, and Green Horse Lope.

Class Routine:

The pattern committee is responsible to set up a safe course that is mindful of each class ability and does not trap a horse or eliminate it by making an obstacle too difficult. Enough space must be provided between obstacles for the judge to evaluate the gait. (30 feet for a jog, 50 feet for a lope.)

- Courses will contain 6-10 obstacles.
- No exhibitor will be allowed to ride the course prior to his or her turn in the class.
- Exhibitor will be given time to walk the course without their horse.

Judging Criteria:

Judging is based on safety, performance, way of going, responsiveness, willingness, and general attitude with emphasis on manner.

- Riders will be asked to move on after 3 refusals or attempts at each obstacle.
- Judges should give credit for any positive action.
- The course may be scored by one judge or divided between two or more judges, with each scoring specific obstacles.

Scoring:

Each obstacle has a value of 10 and is scored according to how rider maneuvers through the entire obstacle.

3 consecutive refusals on each obstacle will be a score of 0 for that obstacle however the member will go on to finish the course.

The following will be considered faults and their severity at the discretion of the judge.

- Doing an obstacle differently than described on the pattern.
- Missing or not attempting an obstacle.
- Failure to complete an obstacle.
- Failure to be in the prescribed gait or the correct lead.
- Not doing the obstacles in the prescribed order.
- Abuse or legal equipment.
- More than one finger between the reins except when changing hands to work on an obstacle.
- Obviously cuing the horse on the neck to lower the head.
- Major disobedience.
- Refusals.

- Tick of the log, pole, cone, or obstacle.
- To or step on log, pole, cone, or obstacle.
- Breaking gait.
- Knocking down elevated obstacles.
- Letting go of the gate.
- Use of either hand to instill fear or praise.
- Failure to meet correct strides on jog over and lope over obstacles.
- Opening mouth excessively exception horses with health issues.
- Fall to the ground of horse or rider.

In-Hand Trail (Western or English Attire)

Class Description:

The class is an in-hand test of horse control and of the handler's ability to guide the horse safely through a series of obstacles.

- Any age horse/breed as long as not ridden at fair on the fairgrounds and cannot be shown in any other riding class.
- The horse must be unsaddled and shown in a safe, properly fitted halter.
- A chain may be used. Guidelines for the use of a chain and for the halter and lead may be found in the showmanship section. (Page 28.)

Class Divisions:

Junior, Intermediate, and Senior.

Class Routine:

The course will be designed so that exhibitors can move quickly and smoothly between obstacles. The course should contain 60 to 10 obstacles and should be designed to be completed in less than 5 minutes. Care should be taken so that there is no advantage to either a large or small horse. The course should be designed to be suitable for all breeds and sizes. A course is considered set once a horse has started the course. There must be no changes made of obstacles or courses after that time. Course must be the same for all exhibitors once class has started unless exclusion is given for a particular class.

Attire:

English or Western Attire is permitted.

Not allowed:

- Spurs
- Chaps

Tack and Equipment:

Required

- A halter with throatlatch and a lead line, suitable for the horse.

Optional

- Correctly attached chain, only if used properly. (See showmanship equipment.)

Not allowed

- Bridles
- Whips/Crops

Obstacles:

Obstacles can be generally the same as for a standard trail class, except lope/canter obstacles are not allowed.

Basis of Judging:

Emphasis is placed on safety, the horse's manners and response to the handler, and the quality of movement.

- The exhibitor should be poised, confident, and courteous and should display safe and quiet techniques in handling the horse.
- Handlers will be asked to move on after three refusals.
- White Ribbons
 - Horse gets loose.
 - Extreme Disobedience.

Tail Obstacles	Mounted	In Hand
Walk/Trot/Lope-Overs	Maximum height 10" 20-24" apart for walkover 3-3.5' apart for the jog 6-7' apart for the lope/canter Spoke style should be set 24' apart halfway No freely rolling poles allowed	20-24" apart for walkover 36" apart for trot overs 10" maximum height
Back-throughs	Minimum of 28" wide on ground Minimum of 30" wide elevated Minimum of 32" wide for barrels or cones	On ground only 36" minimum width if handler is inside poles
Sidepass	Minimum of 24" between poles Maximum height of 24"	Minimum of 30" between poles On ground only
Serpentines	Cones minimum 6' apart Guardrails 3' to either side Cones minimum 3' apart Guardrails 6-8' to either side If tall standards are used, dimensions can be looser	Cones minimum 4' apart for walk Cones minimum 7' apart for trot Guardrails minimum of 4' from cones
Gate	Latch 54-60" high Minimum of 48" wide Rope gate optional	Minimum 4' wide Rope gate optional
Jump	Maximum height 16"	Maximum height 16" Minimum width 12'
Bridge or Plank	Must lie flat on ground Minimum of 12" wide of plank Minimum of 36" wide for a bridge	Must lie flat on ground Not to exceed 12" high Minimum 48" wide if handler to be on bridge
Ground Tie or Hobble	Inside a minimum of a 6' circle	Inside a minimum of a 6' circle
Mailbox	Must be a minimum of 48" from the ground to the bottom of the mailbox	Must be a minimum of 48" from the ground to the bottom of the mailbox
Turn in Box	Minimum 6' sides	Minimum 8' sides
Other obstacles you may want to consider	Tie horse properly, pick up horse's feet, carry item, dis- mount and mount (juniors will not be asked to mount), walk through brush or by a hide, or noisy object	Tie horse properly, pick up feet, walk by hide or noisy object
Obstacles not allowed	Tires, walking on plastic, cinder blocks, fire extinguishers, water boxes with floating or moving objects, pvc pipe, live animals, wire gates, unsafe or	Tires, walking on plastic, cinder blocks, fire extinguishers, water boxes with floating or moving objects, pvc pipe, live animals,

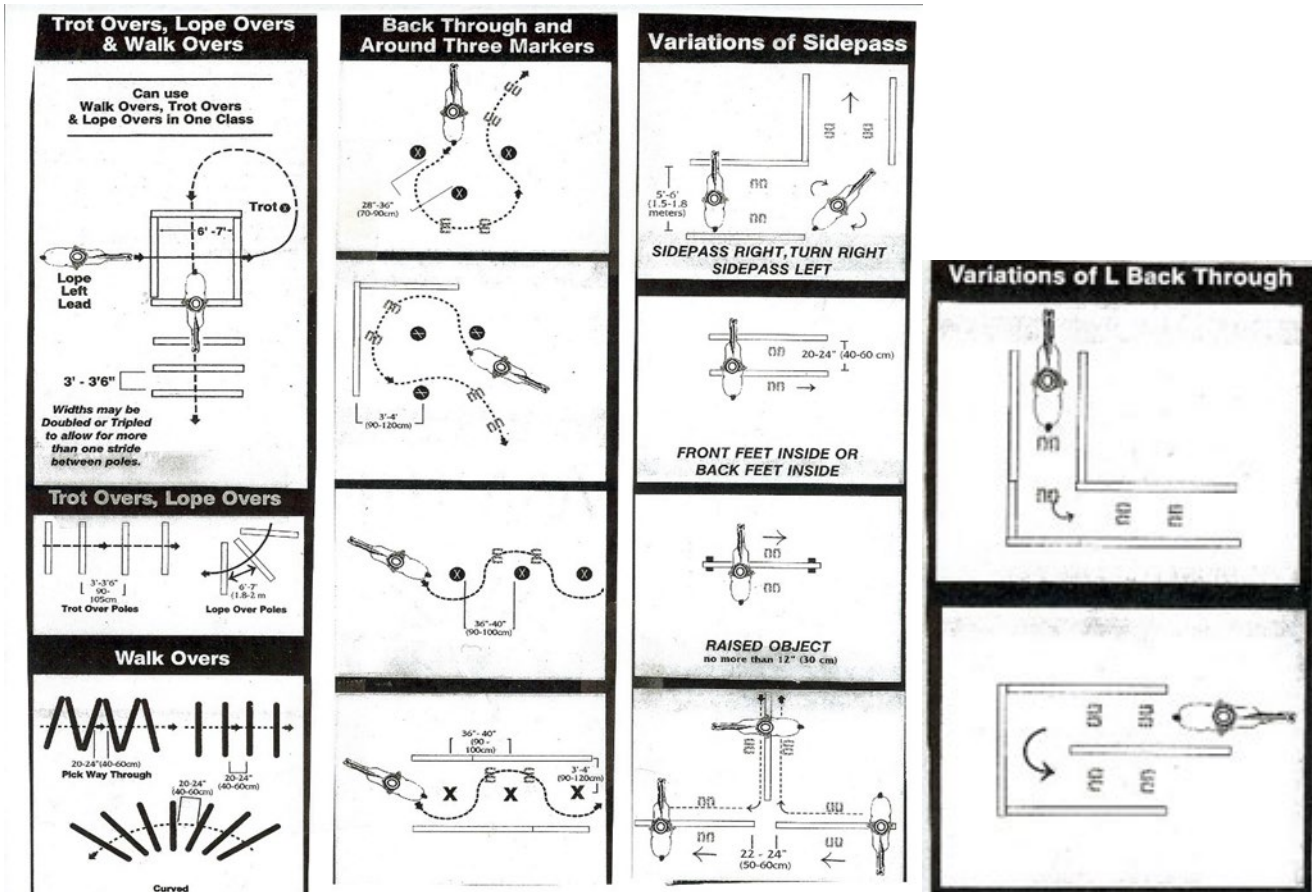

Western Disciplined Rail

Class Description:

This class is to show the ability of a highly trained equine. At all times, the safety of the horses and exhibitors are to be the first concern.

Class Divisions:

Junior, Intermediate, and Senior.

Class Routine:

The class routine shall be to perform work on the rail, and may include but is not limited to:

- A short walk, jog, or slow lope.
- A hand gallop (no more than eight horses at a time, twice around the ring).
- Starting into a lope from a halt.
- Starting and traveling in the incorrect lead.
- Side pass both away from the rail (at least five steps) and then back to the rail.
- Turn on forehand and turn on hind quarter (once each way).

- Stop and stand quietly on a loose rein.
- Judge may ask for a reverse at the jog but not at the lope. Judge may ask for additional safe work.

Judging Criteria:

Judge shall work the entries adequately but must not overwork them. This is not a game or a fault and out class and shall not be judged on an elimination basis. Final judging shall be on the basis of the best overall disciplined rail performance including responsiveness, manners, and quality of movements. At all times, the safety of the horses and exhibitors are to be the first concern.

Scoring:

To be judged on performance, smoothness, obedience, and consistency.

WESTERN EQUITATION

Class Description:

The horse should do what the rider asks with the least possible effort on the part of the rider and least amount of resistance from the horse.

Gaited horses that pace, slow gait, fox trot, single foot rack, or perform a running walk may be worked with the class adjusting their speed to conform to the other horses.

Class Divisions:

Walk Trot, Junior, Intermediate, Senior, Green Horse Walk Trot, and Green Horse Lope.

Class Routine:

Exhibitors will enter the ring in a counterclockwise direction at the walk and complete one circuit of the arena. The exhibitors will line up to complete individual pattern. Upon completion of exhibitor's pattern, they will find a place on the rail and wait for all exhibitors to complete the pattern.

Tests:

- Regular or extended walk.
- Regular or extended jog, trot, or intermediate gait. The rider may sit the trot or lean slightly forward, keeping contact with the thighs, with more weight in the stirrups and the seat coming slightly out of the saddle. In either case, the rider must demonstrate an extended gait.
- Lope or canter (on the correct lead or a counter canter).
- Hand gallop for hunt seat, extended canter for saddle seat, or extended lope for western.
- Perform figure-8s, serpentines, circles, straight lines, or other specific pattern at any of the above gaits.
- Simple, interrupted, or flying lead changes.
- Ride without stirrups and drop and pick up stirrups.
- Haunch or forehand turn (need forward motion).
- Side-pass or two-track.
- Transition from any gait to halt followed by "on the buckle" or loose rein.
- Back up.

- Stand for inspection.
- Rollbacks.
- Mount and dismount (juniors may NOT be asked to mount).
- Balanced stops.
- Answer questions from project materials.

Pattern Maneuvers:

- Walk Trot, Green Horse Walk Trot
 - Walk, trot in a straight line, curved line, serpentine, circle, or figure 8, back or halt.
- Junior, Green Horse Lope
 - Walk, jog, and lope in a straight line, curved line, serpentine, circle, or figure 8. Any combination of stop, back, and simple turns.
- Intermediate
 - Walk, jog, and lope in a straight line, curved line, serpentine, circle, or figure 8. Any combination of stop, back, and simple turns pivot including spins and rollback on the haunches. Side-pass, simple lead changes, and riding without stirrups.
- Senior
 - Walk, jog, and lope in straight line, curved line, serpentine, circle, or figure 8. Any combination of stop, back, and simple turns. Counter canter, forehand turns, and extended lope.
- **Unacceptable Obstacles**
 - Reverse at the canter.

Western Equitation Judging Criteria:

The member will be judged on correct posture, smooth gait transitions, and effective use of aids, with special emphasis on light hands. The performance of the horse is not to be considered more important than the methods used by the rider in obtaining the performance.

The member, horse, and equipment may be inspected at any time during the contest. Members using unsafe equipment may be asked to leave the ring.

A rider is penalized if they lose a stirrup, changes hands on the reins, touches any part of the saddle with their free hand or falls from the horse.

Scoring:

100 points total.

<i>Member and appointments</i>	Clothing, equipment, courtesy, poise ...	15%
<i>Seat and hands</i>	Seat, posture, head, legs, hands, balance, distribution or weight, aids	35%
<i>Performance</i>	Standing, starting, walking, jogging, figure-8 or equivalent at lope or canter from walk, stopping, turning, backing, general control ...	50%

BAREBACK EQUITATION (English or Western)

Exhibitors may be asked to perform any test listed in equitation. Western riders must sit the jog or intermediate gait. No mount or dismount is allowed.

In bareback equitation the rider is using Western Equitation without a saddle.

- The tack and attire is the same as for equitation class except no saddle is used.
- Chaps are not allowed in Western Bareback Equitation.

Class Divisions:

Walk Trot, Junior, Intermediate, and Senior.

WESTERN PLEASURE

Class Description:

The emphasis of this class is on the horse, its way of going and ability to walk, jog, and lope while on the rail and keeping a pleasurable demeanor.

Class Divisions:

Walk Trot, Junior, Intermediate, Senior, Green Horse Walk Trot, and Green Horse Lope.

Class Routine:

- Exhibitors will enter the ring at the walk.
- Horses must work both directions in the ring at all three gaits to determine their ability with different leads. (Except walk trot class.)
- Horses are to reverse to the inside (away from the rail). They may be required to reverse at the walk or trot, but not the lope.
- Horses will be required to back. Horses are to back readily and stand quietly.
- Use of rope or riata is optional. If used, the rope or riata must be coiled and attached to the saddle.
- Entries will be penalized for excessive speed or being on wrong leads.

Judging Criteria:

- Horses are to be judged on performance, apparent ability to give a good pleasurable ride and manners, according to the breed being shown.
- The rider should sit to trot and NOT post. At the lope he should be close to the saddle. All movement of the horse should be governed by the use of imperceptible aids. Exaggerated shifting of the rider's weight is not desirable.
- A rider is penalized if they lose a stirrup.
- Horses are to be shown in any legal bit (see pages 24-25) according to the age of the horse. Chain chin straps are permissible but must meet the approval of the judge be at least one-half inch wide and lie flat against the jaw of the horse.

Scoring:

Horses way of going/transitions ...60% Riders use of aids ... 30% Tack & Appointments ...10%

WESTERN RIDING

Class Description:

This class is neither a stunt nor a race but should be completed with reasonable speed. This class is a competition of the performance of a sensible, well-mannered, free and easy moving horse. Emphasis will be placed on the smoothness and even cadence of gaits and the horse's response to the rider.

Class Divisions:

Junior, Intermediate, Senior, and Green Horse Lope.

Class Routine:

Exhibitors will be at the gate waiting for their turn.

Judging Criteria:

The horse will be judged on quality of gaits, lead changes at the lope, manners, and disposition. Credit shall be given for the evenness of cadences of gaits (starting and finishing pattern with the same cadence). The horse's ability to change leads precisely, easily, and simultaneously, both hind and front, at the center point between markers. The horse should have a relaxed head carriage showing response to the rider's hands with moderate flexion at the poll. Horses may be ridden with light contact or on a loose rein. The horse should cross the log both at the jog and the lope without breaking gait or radically changing stride. The judge is responsible for the pattern being correctly set.

Scoring:

An exhibitor will be penalized for each time one of the following occurs. The severity of the fault shall be at the discretion of the judge.

- Failure to change leads.
- Kicking out.
- Blatant disobedience.
- Not performing a specific gait or stopping when called for in the pattern.
- Break of gait.
- Simple lead changes.
- Additional lead changes anywhere in the pattern.
- Hitting, rolling, or ticking the log.
- Off course.
- Knocking over the marker.
- Completely missing the log.
- Refusal.
- Opening of mouth excessively.
- Stumbling or falling.
- All western pleasure faults will be included.

1. Walk at least 15 feet and jog over the log.
2. Transition to left lead and lope around the end.
3. First line change.
4. Second line change.
5. Third line change.
6. Fourth line change. Lope around the end of the arena.
7. First crossing change.
8. Second crossing change.
9. Lope over log.
10. Third crossing change.
11. Fourth crossing change.
12. Lope up the center, stop, and back.

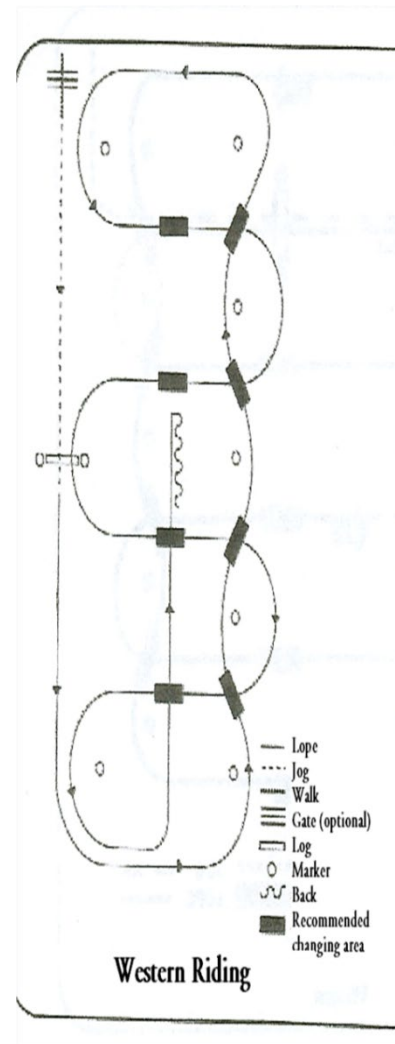

REINING

Western Reining:

Class Description:

To rein a horse is not only to guide but to also control his every movement. The best-reined horse should be willfully guided or controlled with little or no apparent resistance. The horse and rider that completes the pattern fluently and effortlessly with reasonable speed throughout the pattern will be given credit. Smoothness, finesse, attitude, and quickness of correct maneuvers will also be credited. See description of maneuvers starting on page 65.

Class Divisions:

Walk Trot Reining Control, Junior, Intermediate, Senior, Green Horse Lope, Working Ranch Green Horse, Amateur, Intermediate, Advanced.

Reining Patterns:

The patterns are to be worked as stated, not as drawn. The drawn pattern is just to give a general idea of what the pattern will look like in the arena.

Markers are mandatory for all patterns. Markers will be placed on the wall or fence of both sides of the arena to the approval of the judges with the following guidelines.

- At the center of the arena.
- End markers for rein work should be placed at least 20-30 feet from the end of the arena.
- Where designated in the pattern for stops to be beyond the markers, the horse should begin the stop after he/she passes the specified marker.

Judging Criteria:

Scoring will be on the basis of 0 to infinity, with a 70 denoting average performance. Excess rein may be straightened at any place a horse is allowed to be completely stopped during a pattern. Each reining pattern is divided into sets of maneuvers. It is a judge's responsibility to evaluate these maneuver groups individually and rate each maneuver group on the following scale.

- -1 ½ - Needs Extreme Improvement
- -1 - Needs Extreme Improvement
- - 1/2 - Needs Improvement
- 0 - Correct
- + ½ - Good
- +1 - Very Good
- + 1 ½ - Excellent

½ Point Penalties:

Not changing leads simultaneously. Over or under spin by 1/8 turn. Starting a circle at a jog jogging first two strides. Jogging in excess of one-quarter of circle or one-half the length of the arena.

1 Point Penalties:

Out of lead. Out of lead each ¼ circle. Slipping a rein in the bridle. Scotching or anticipating a stop. Over or under spinning by ¼ turn.

5 Point Penalties:

Use of either hand to instill fear or praise. Holding the saddle with either hand. Blatant disobedience, defined as kicking, biting, bucking, rearing, striking, or obviously insubordinate. Jogging in excess of one-half circle or one-half the length of the arena. Horse balking. Failure to complete the pattern as given using two hands on the reins with a shanked bit.

0 Score:

Spurring or hitting in front of the cinch at any time. Bloody mouth (inside). Out of control (any horse that is out of control while working the cow, thus endangering the rider, i.e. crossing the path of the cow, shall be called off the cow). If a rider hits or kicks the animal being worked, with the romal or reins, in an abusive manner. On trot in patters, failure to "stop" before executing a canter departure. On run-in patterns, failure to be in lope before reaching the first marker. A stop in the first one-quarter of the circle, after a lope departure, is a break of gait. Leaving the working area before the pattern is complete.

Performing the maneuvers other than in the specified order. Failure of an exhibitor to attempt to complete the pattern. Fall of horse or rider.

Walk Trot Reining Control:

Class Description:

This class is to help teach walk trot exhibitors the basic control needed for reining events. In the walk trot pattern the exhibitor will be judged on their ability to perform a pattern as effectively as possible. All trotting should be done in a "working trot."

Judging Criteria:

The emphasis of this class is on the accuracy of the pattern, and the exhibitor's ability to guide the horse with minimal resistance, and effort. Excessive hand movements and spurring will be penalized along with unwillingness of the horse and breaking of gait. Breaking of the pattern and all other faults are the same as in reining. (See reining rules.)

Scoring:

Pattern Accuracy 50%

The riders guiding ability 30%

The horse's willingness to be guided 20%

Class Routine:

Each exhibitor will perform the pattern one entry in the ring at a time. The exhibitor will wait for the judge to connect the start of pattern.

Rein Work Must Consist of the Following:

Circles:

Circles are a controlled maneuver at the lope in the designated area of the arena. The horse shall lope in an even, fluid manner with a minimum of rider contact and/or commands. Emphasis on the scoring shall be given to the contestant exhibiting smooth, controlled figure eights with easy lead changes. Circles shall be run and/or begun on the correct lead. The right and left circles shall have a common center line in the middle of the designated area. Speed and size of the right circles shall be exactly the same as the speed and size of the left circles. Circles shall be run far enough from arena wall that it does not affect the circles.

Lead Changes:

The act of changing the propelling side of the horse's body when changing the direction traveling at a lope. The lead change must be executed at a lope with no change of speed or gate. Pre-amateur, amateur, and intermediate may do a simple lead change. The horse shall change leads at the exact location dictated in the pattern description and shall change in one stride. A horse shall be considered out of lead if both front and rear leads are not changed in the same stride.

Jogging:

Jogging in excess of one-quarter of circle or one-half of the length of the arena will result in -1/2 point for each occurrence.

Run-Down:

Runs lengthwise through the arena. The horse shall demonstrate a relaxed fluid attitude when starting a run down and throughout the maneuver. The horse shall use controlled speed consistent with the size of the arena and the condition of the ground. The horse shall travel in a straight line with a minimum of contact with the rider. Straight, controlled run-downs with square, smooth stops, maintaining, suppleness and proper head position are desirable. They shall be made as described in the given pattern unless the judge indicated otherwise due to arena conditions.

Stops:

Shall be in line with the direction of travel. Horse shall have its hocks well under it during the entire stop, maintaining a proper head position and response to a light rein.

Spins:

Consistent and positioned 360 degree turns executed with the inside hind quarter (pivot) remaining stationary. Spins shall be smooth and efficient. The location of the hind quarters shall be fixed at the start of the spin. The horse shall stop the spin exactly as dictated by the pattern description. The right and left spins shall have a similar speed and balance.

Back-Up:

The horse being caused to move in a reverse motion in a straight line for a required distance. The horse shall begin the back-up in a controlled manner and shall continue to back-up without hesitation until directed to stop by the rider. In the instance where a horse backs up where a back up is not specified in the pattern, the penalty score of 0 will be incurred when the horse backs more than 2 full strides. It is important that one stride is defined as the complete movement or steps of all 4 legs, one time. In this situation it is very helpful for a judge to watch and count the steps of the front feet. Up to and including 4 steps of the front feet in the not required back-up receives no penalty; five steps and beyond constitutes the inclusion of a maneuver not specified and this a penalty score of 0.

Hesitate:

Hesitation is only long enough to show the completion of one maneuver before the next one starts. There shall be slight hesitation to indicate each maneuver.

Rollbacks:

A maneuver that combines a stop, turn over the hind quarters and exit in one fluid motion. The rollback must be executed with no more than slight hesitation after the stop and the horse shall not step ahead or back-up prior to the turn. The horse shall be in position to lope off in a straight line when executing a rollback.

Definition of fall of horse:

When a horse's shoulder and hip are on the ground and all four feet are facing in one direction. Fall of horse in any event receives a score of 0.

Definition of fall of rider:

Rider is no longer astride the horse.



Walk Trot Reining Control Pattern:

- Enter the ring and walk past the 1st outer marker.
- Continue at a trot past the end marker.
- 180 degree turn to the left.
- Trot to the center.
- Stop.
- Back 5 steps.
- 90 degree turn to the left.
- Trot a large right circle.
- At center change to a trot and complete a small left circle
- Stop in canter and wait for dismissal.

left circle

Junior, Green Horse Lope, WR Green Horse, WR Amateur Pattern #1:

1. Run down center of the arena past center marker, stop, and back up. Hesitate.
2. Make a quarter turn to the left.
3. Lope a large, fast circle to the right, followed by a small, slow circle to the right. Change leads.
4. Lope a large, fast circle to the left, followed by a small slow circle to the left.
5. Stop.
6. Complete two spins one direction. (Choose to spin two times to either the left or the right, your choice.)
7. Pattern Complete. Exit Arena.

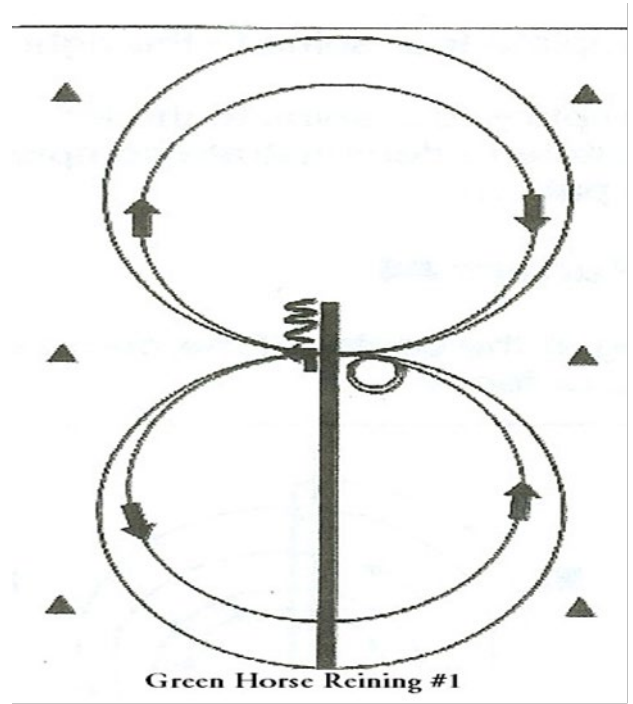

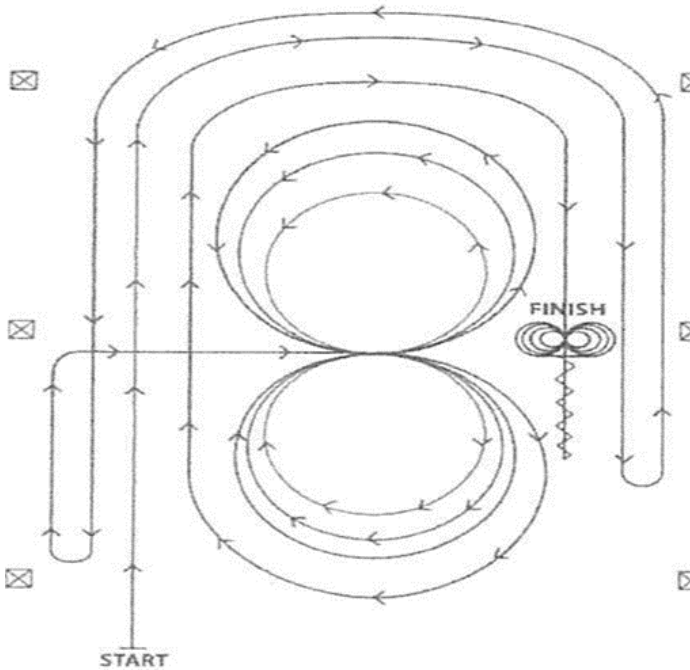

Intermediate & Senior, WR Intermediate & Advanced Reining Pattern #1:

1. Beginning and staying at least 20 feet from the fence, lope straight up the left side of the arena, circle the top end of the arena, run straight down the opposite or right side of the arena past the enter marker, and do a left rollback- no hesitation.
2. Continue straight up the right side of the arena staying at least 20 feet from the fence, circle back around the top of the arena, run straight down the left side of the arena past the center marker, and do a right rollback - no hesitation.
3. Continue of the left side of the arena to the center marker. At the center marker, the horse should be on the right lead. Guide the horse to the center of the arena on the right lead and complete three circles to the right. The first two circles large and fast, the third circle small and slow. Change leads at the center of the arena.
4. Complete three circles to the left. The first two large and fast and the third circle slow and small. Change leads at the center of the arena.
5. Begin a large, fast circle to the right but do not close this circle. Continue up the left side of the arena staying at least 20 feet from the fence, circle the top of the arena, run straight down the opposite or right side of the arena past the center marker, and do a sliding stop. Back up at least 10 feet. Hesitate.
6. Complete four spins to the right.
7. Complete four spins to the left. Hesitate to demonstrate completion of the pattern.

Intermediate & Senior, WR Intermediate and Advanced Pattern #2:

1. Walk to the center of the arena; the horse should be facing the left fence.
2. Complete four spins to the right.
3. Complete four spins to the left.
4. Beginning on the left lead, complete three circles to the left. The first two circles large and fast, the third circle small and slow. Change leads at the center of the arena.
5. Complete three circles to the right. The first two circles large and fast, the third circle slow and small. Change leads at the center of the arena.
6. Begin a large fast circle to the left, but do not close this circle. Run up the right side of the arena past the center marker and do a ride rollback at least 20 feet from the fence - no hesitation.

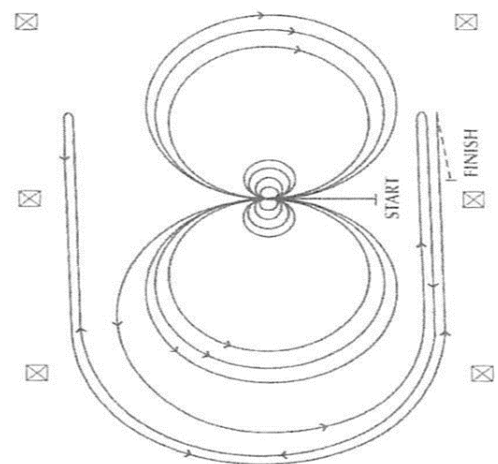

7. Continue back around the previous circle to the right, but do not close this circle. Run up the left side of the arena past the center marker and do a left rollback at least 20 feet from the fence - no hesitation.
8. Continue back around the previous circle to the left, but do not close this circle. Run up the right side of the arena past the center marker, and do a sliding stop at least 20 feet from the fence. Back up at least 10 feet. Hesitate to demonstrate a completion of the patter.
9. The bridle may be dropped at the judge's discretion.

Intermediate & Senior, WR Intermediate and Advanced Pattern #3:

1. Run with speed to the far end of the arena past the end marker and do a left rollback. Do not hesitate.
2. Run to the opposite end of the arena past the end marker and do a right rollback. Do not hesitate.
3. Run past the canter marker of the arena, do a sliding stop, and back straight to the center of the arena. Hesitate.
4. Complete four spins to the right.
5. Complete four and one-quarter spins to the left. Hesitate.
6. Beginning on the right lead, complete three circles to the right, the first two circles large and fast, the third circle small and slow. At the center of the arena change leads.
7. Complete three circles to the left, the first two circles large and fast, the third circle small and slow. At the center of the arena, change leads.
8. Begin a large fast circle to the right. Do not close this circle but run straight down the side of the arena past the center marker, and do a sliding stop approximately 20 feet from the fence. Hesitate to demonstrate the completion of the pattern.
9. Bridle may be dropped at the judge's discretion.

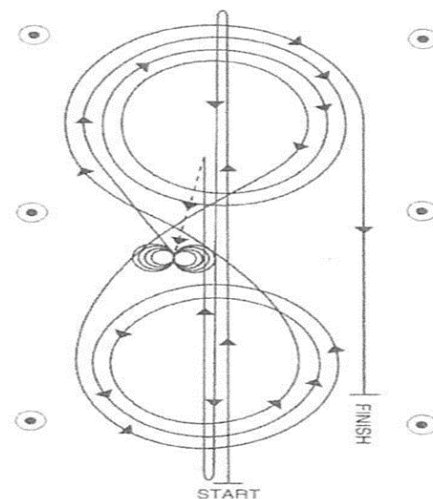

WORKING RANCH HORSE VERSATILITY

Members in Working Ranch Horse must be enrolled in the basic 4-H horse program. **Members must attend 6 working ranch horse riding meetings, due to working with cattle and ropes. Other horse-riding meetings will not count.** They must complete all necessary elements of the Elmore County 4-H horse program.

- Member must show a designated project horse in showmanship, show trail, and at least one other show class in addition to working ranch horse classes.
- WRH members must participate in all WRH classes at fair.
- For tack and attire see tack section of this book.
- Chaps and carrying of rope or riata are optional.
- Horse may be of any age shown in any legal bit as described in tack section of this book.
- WRH is divided by experience level by horse and rider rather than age. **No walk trots.**
- WRH Committee for evaluations will be appointed by the chairman and horse working group.
- WRH members are to be evaluated by the appointed committee 2-3 weeks before fair for what division they will be in.
 - All WRH members are to be evaluated regardless of what division they are in,

- Lame horses will not be evaluated. Member must be evaluated on all horses they will be using for working ranch horse.
- If you are a green rider, it is strongly suggested that you complete 1 or 2 years of general horse program before you enroll in working ranch horse.

Classes:

Classes that may be offered depend on the availability of resources.

Clover bud: Dummy Roping. (Not a competition event, same rules apply as dummy roping 1.)

Amateur: Dummy roping or ranch roping*, Herd work, level 1 fence work, ranch pleasure, and reining.

**Amateur WR competitors may rope live cattle if deemed safe by evaluator.*

Intermediate: Ranch roping, herd work, level 2 fence work, ranch pleasure, and reining.

Advanced: Ranch roping 2, herd work, level 3 fence work, ranch pleasure, and reining.

Dummy Roping 1:

This is a beginner class. The youth rope the dummy on the ground. They are judged on handling the rope-making a loop, swing, coiling, and other areas as listed below. They will be allowed 3 loops or 1 ½ minutes per end whichever happens first. Must rope both head and heels.

Points	Dummy/ Roping Area of Consideration
+3/-3	Handling the rope (and reins)
+3/-3	Positioning of the competitor/horse
+3/-3	The swing and throw of the rope. Attitude toward the horse and cattle. (Amateur - attitude of competition)
+3/-3	Posture on the horse/proper use of tack etc. (Amateur- proper use of rope)
+3/-3	Head Catch
+3/-3	Heel Catch
+3/-3	Overall eye appeal
-3	Losing or dropping the rope
0	*Amateur - Roping dummy on the ground
3	*Amateur - Roping dummy on horse back
5	*Amateur - Roping live cattle

***Points are to be awarded to amateur division only.** All competitors will start with 70 points. Points will be deducted or added based on performance.

1. Competitors roping live cattle must demonstrate their ability to rope cattle from within a group of cattle. This class is offered only to participants in WRH.
2. Participants in this class will enter a pen where 5 or more head of cattle will be waiting. Ropers will work with a helper or hazer.
3. Horses used in this class must not break into a faster gait than a trot (points may be deducted at the discretion of the judge).
4. Ropers are required to use a breakaway hondo, and the free end of the rope is to be dalled to the saddle horse until the hondo breaks. At that point, the roper will recoil the rope and rope another animal. Must rope head and heels. Hazer/Helper may help with the breakaway hondo.

5. A roper must use the same rope in this class for both heading and heeling. If a rope is lost during the roping the contestant will retrieve rope and continue for remaining time. Hazer may help the contestant retrieve the rope.
6. When the judge/timer drops the flag, or contestant crosses a designated timeline, time will start, the roper will rope as many cattle as he/she can within 4 minutes. (2 minutes for heads, 2 minutes for heels) time limit. The helper/hazer in the pen is there to help set the cattle up for the roper.
7. At the end of 1 minute, the judge will alert the contestant that he/she has 1 minute left and time will end at 2 minutes. At the end of 2 minutes the roper must switch to roping the opposite end. Warning will be given again at 1 minute and time will end at 2 minutes.
8. Any verbal abuse by the roper or the hazer will not be tolerated. The roper will be disqualified at the discretion of the judge.
9. A legal head catch will consist of any catch that goes over the head or horns. A legal hell catch will be from the heel end only.
10. Cattle will be changed according to the number of ropers and cattle used.
11. Undue roughness on cattle or horses will be counted as a disqualification at the discretion at the discretion of the judge. All decisions of the judge will be final.

Bit Check:

Each bit and horse's mouth may be views by the appointed representative or the judge to determine if the bit or hackamore is legal, and to check for blood inside the mouth at the judge's discretion. The judge(s) and working ranch chairman has the authority to disqualify the contestant.

Herd Work:

Contestants will ride into a herd of cattle and will sort out an animal keeping him from the herd.

- Time will begin when a rider crosses a timeline just prior to entering the herd. The contestant shall approach the herd with no hesitation, weaving or reluctance on the part of the horse to enter the herd sufficiently deep enough to show his ability to make a cut.
- The rider will then quietly separate his/her cow from the herd. The horse shall work quietly, but alertly, causing very little disturbance to the herd or the animal brought out.
- Once the contestant has shown that he/she has control, then he/she can allow that animal back into the herd and sort out another one.
- Unnecessary roughness or disturbing the herd excessively could result in disqualification.
- Remember that this is not team sorting. On a ranch you sort quietly and without stirring the cattle up as much as possible.
- Intermediate and Advanced will be required to do deep cuts. Contestants shall walk to the herd each time. Points will be deducted for trotting to the herd.

Judging:

- Minimum number of cattle in the herd will be ten. The number will be preferably ten, however will be determined by availability of cattle and the number of contestants.
- For herd work, the start line marker should be approximately 60-70 feet from the back-fence marker to the timeline.
- The judges shall be located approximately 120 feet from the back of the arena. The placement of the back fence marker should be at the judge's discretion.
- There is a 2 ½ minute time limit. A warning will be given at the one-minute point in the run.

- Credit will be given for driving cattle, clearing the herd by a sufficient distance, and setting up a cow while holding it in a working position as near the center of the arena as possible. The degree of difficulty, eye appeal, and the amount of courage in staying on a tough cow will be taken into consideration.
- The amount of time actually spent working cattle in the 2 ½ minute period will have a positive effect on the total score. The horse should show a great deal of expression but no ill will toward the animal.
- Judging will end at the whistle.

Scoring:

General Description:

Credit must always be given when applicable, even when there is a penalty involved. When the judge is in doubt, benefit always goes to the contestant. The scoring system is based on 60-80 points, unless otherwise stated. The lowest score possible is 60 points and the highest score possible is 80. The average score for a typical work is 70 points. Half points may be used.

- The contestant is judged from the time that he/she enters the arena until he/she completes the patter.
- Horses are judged on performance only.
- A judge may blow his/her whistle at any time to terminate the work. A score of 0 will be given if the work is not complete at that time.
- Horse must appear visibly sound at the beginning of the run. Obvious lameness will be cause for immediate disqualification.

Penalty Points:

- 1-point penalties
 - Loss of working advantage
 - Noise directed by contestant toward cattle
 - Working out of position
 - Toe, foot, or stirrup on shoulder
- 3-point penalties
 - Cattle picked up/running into a scattering herd
 - Failure to make a deep cut
 - Failure to separate a single animal after leaving the herd
 - Blatant disobedience, defined as kicking, biting, bucking, rearing, striking, or obviously insubordinate.
 - Horse turns tail
 - Using two hands on the reins with a shanked bit
- 0 score
 - Spurring or hitting in front of the cinch at any time
 - Illegal equipment
 - Leaving working area before time expires
 - Fall of horse or rider
 - Out of control (any horse that is out of control while working the cow, thus endangering the rider, i.e. crossing the path of the cow shall be called off the cow).

- Bloody mouth (inside)
- If a rider hits or kicks the animal being worked with the romal or reins in an abusive manner
- Failure of an exhibitor to attempt to complete the work

Fence Work:

The required pattern for the fence work is boxing, fence turns, and circles, in that order depending on the level the contestant is in.

- When enough cows are available, the contestant should receive a new cow if the cow drawn is unreasonably difficult or unworkable or when a cow leaves the working area. Scoring will begin again with the new cow.
- Once a rider has committed to circling a cow, if the cow falls down no new cow will be awarded. The rider should complete the run by riding around the fallen cow to fulfill circling requirements.
- The judge should take into consideration the size of the area, condition of the ground and disposition of the cattle in scoring each work. If ground, area and/or weather conditions are deemed unfavorable by the exhibitors, they may inform the judge who may elect to alter the required cattle work for safety reasons.
- The judge may blow his/her whistle at anytime during the work. One whistle to terminate the work, two whistles to award a new cow.
- If the judge blows his whistle during the work, the contestant does not have the option to continue working. If an exhibitor continues to work after the whistle has been blown for a new cow, the exhibitor will be given a score of zero. With a multiple judge system, any one judge may terminate the work or signal for a new cow.
- Judging ends when the whistle blows. A score of zero will be given if the work is not complete at that point.
- In the cow work phase of any class one hand on the horse may be used to prevent the fall of the rider.

Fence Work:

Judging begins when the contestant enters the arena. At the start of the work, each contestant, upon receiving a cow in the arena, shall box (hold) that cow on the prescribed end of the arena for a sufficient time to demonstrate the ability of the horse to contain the cow at that end. After a reasonable amount of time, the contestant will...

- **In the amateur division-** will box the cow and then will bring the steer down the rail (grandstand side of the rail) and then into the catch pen. Judge will call time when he has seen enough boxing, then the gate will be opened, and the contestant will continue to pen the animal.
- **In the intermediate division-** will box the cow and then will bring the steer down the rail at a point just past the power pole, the contestant must turn the steer back the other direction. The steer is to be taken past the power pole on the other end, turned back and brought down to the catch pen.
- **In the advanced division-** will box the cow and then will move the steer down the fence making at least one turn each way on the fence. Then the contestant shall take the cow to an open part of the arena and circle the animal at least one in each direction. Work is complete when the last circle is completed.

Boxing: Working the cow on the end of the arena until such time as the contestant has proven the ability of the horse to hold the cow. The horse should exhibit cow sense and natural cow working ability without excessive reining or spurring. In the head-to-head working position, the degree of difficulty shall be considered. Time limit for pre-amateur will be 50 seconds.

Turning on the Fence: A fence turned is defined as a turn in which the cow, while being run down the fence on one side of the arena, or in the "open field", is turned in a different direction and held near the same fence, or the same side of the area, while being run in the new direction. The exhibitor must be close enough to the cow to be the cause of the turn. The situation where a horse and rider attempt to turn the cow and the cow exits the turn behind the horse is also considered to have satisfied the fence turn requirement. The route of the cow being worked has been altered because of the influence of the horse and rider. The actual stopping or turning of the cow by the end fence will not qualify as a fence turn. To qualify as a fence turn must be accomplished without the aid of the end fences to stop or turn the animal being worked. During the turn the horse should use himself in a controlled athletic manner, using his hocks to stop and drive out of the turn, while using its front end to balance and turn. The contestant must get at least on turn in each direction. More than two good turns in each direction should not result in extra credit but also should not be penalized unless the cow thereby too exhausted to circle correctly. One turn each way may not be necessarily result in extra credit if horse and/or cow are out of control.

Circling: Maneuvering the cow smoothly at least 360 degrees in each direction without interference from the fence. The circle's size, symmetry, speed and relative balance from right and left show control. Tightening the circles down with a fast head-to-head speed will be a credit situation. The circles should be completed before the cow is exhausted.

Scoring:

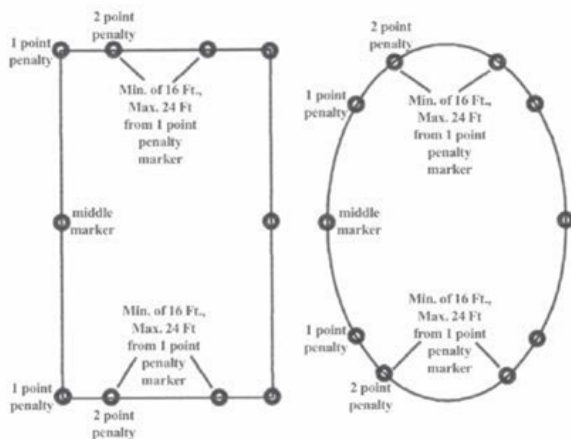

General Description - Credit must always be given when applicable, even when there is a penalty involved. When the judge is in doubt, benefit always goes to the contestant. The scoring system is based on 60-80 points, unless otherwise stated. The lowest score possible is 60 points and the highest score possible is 80. The average score for a typical work is 70 points. Half points may be used.

- The greater the difficulty of the run, the more credit should be given. The difficulty may be due to the extreme speed or stubbornness of the cow, or the cow's reluctance to move down the fence when sufficiently driven by the contestant.
- The most controlled cow work with the highest degree of difficulty should be marked the highest.
- The contestant is judged from the time that he/she enters the arena until he/she completes the pattern.

- Horses are judged on performance only.

Penalties:

- 1-point penalties
 - Loss of working advantage
 - Using the corner or the end of the arena to turn the cow. (In an oval arena when the cow's head breaks the plane of the end marker.)
 - Changing sides of the arena to turn cow. (1 point each time)
 - For each length horse runs past cow. A length by is 1 horse length of daylight between the cow's head and the top of the horse's tail.
 - Slipping a rein.
 - Failure to drive the cow past the middle marker on first run down the fence.
 - Excessive whipping, spurring, or hollering.
- 2-point penalties
 - Going around the corner of the arena before turning the cow. (When the cow's head breaks the plane of the 2-point penalty marker.
- 3- point penalties
 - Exhausting or overworking the cow before circling
 - Hanging up on the fence. (Refusing to turn.)
 - Knocking down the cow without having a working advantage.
- 5- point penalties
 - Not getting one turn each way.
 - Blatant disobedience, defined as kicking, biting, bucking, rearing, striking, or obviously insubordinate.
 - Turn tail
 - Using 2 hands on the reins in a bridle or two-rein class.
 - Balking
- 0 score
 - spurring or hitting in front of the cinch at anytime
 - out of control (any horse that is out of control while working the cow, thus endangering the rider, i.e. crossing the path of the cow, shall be called off the cow).
 - Bloody mouth (inside)
 - Illegal equipment
 - Fall of horse or rider
 - Schooling of the horse between the rein and cow work when the cow work immediately follows rein work.
 - Schooling of horse between cows if a new cow is awarded. Schooling defined as gaining an advantage by excessive pulling, turning, stopping, or backing.
 - If a rider hits or kicks the animal being worked with the romal or reins in an abusive manner.
 - Failure of an exhibitor to attempt to complete the work.

NOTE: A judge may blow his/her whistle at anytime to terminate work. A score of zero will be given if the work is not complete at that time.

Reining:

The patterns are to be worked as stated, not as drawn. The drawn pattern is just to give the general idea of what the pattern will look like in the arena.

Markers are mandatory for all patterns. Markers will be placed on the wall or fence of both sides of the arena to the approval of the judges with the following guidelines:

- At the center of the arena.
- End markers for rein work shall be placed at least 20-30 feet from the end of the arena.
- Where designated in the pattern for stops to be beyond a marker, the horse should begin the stop after he/she passes the specified marker

Reining patterns will be set by the judge and posted in accordance with 4-H rules.

Ranch Riding Pleasure:

This class shows the horse's ability to move at a working speed with a rider. Horses will be shown at three gaits- walk, trot, and lope- in each direction of the arena. Horses will also be asked to reverse away from the rail, to stop and to back.

The judge may ask for an extended trot and an extended lope in at least one direction of the ring. May ask for an extended walk. **EXCEPTION: Green horse- the judge may ask for an extended trot only in one direction of the ring. No Extended Lope.**

- A horse will be given credit for traveling with his head held in a normal position, ears alert and moving at a natural speed for the gait requested.
- Credit will also be given for making a smooth transition between the gaits, for keeping the correct lead, and for maintaining the gait requested until the judge requests a change.
- A rider must show his horse with only one hand on the reins, unless being shown in a snaffle bit or hackamore (bosal).
- Finalists may be worked individually at the discretion of the judge. Judges are encouraged to work exhibitors thoroughly if time permits. Judge may ask for a reverse at the walk or trot, or side pass.

Penalty Points:

Scoring will be on the basis of 0-infinity, with 70 denoting an average performance. Each obstacle will receive an obstacle score that should be added or subtracted from 70 and is subject to a penalty that should be subtracted. Will add a pattern if need a tie breaker.

Faults to be scored according to severity:

- Excessive speed (any gait)
- Being on the wrong lead
- Breaking gait (including walking when called for)
- Excessive slowness in any gait, loss of forward momentum (resulting in an animated and/or artificial gait at the lope).
- Failure to take the appropriate gait when called for (during transitions, excessive delay will be penalized)

- Touching horse or saddle with free hand
- Head carried too high
- Head carried too low (tip of ear below the withers)
- Over flexing or straining neck in head carriage so the nose is carried behind the vertical
- Excessive nosing out
- Opening mouth excessively
- Stumbling
- Use of spurs forward of the cinch
- If a horse appears sullen, dull, lethargic, emaciated, drawn, or overly tired
- Quick, choppy or pony strided
- If reins are draped to the point that light contact is not maintained
- Overly canted at the lope. (When the outside hind foot is further to the inside of the arena than the inside foot.)

Ranch Trail:

This class contains a course with a minimum of six obstacles and is designed to show a horse's ability and willingness to perform several tasks that might be asked of them during the course of a normal day's ranch work. Whenever possible, realistic or natural obstacles are encouraged.

- The course is encouraged to be set outside of an arena using the natural terrain of the land whenever possible. The horse will be judged on three gaits -walk, trot and lops. A horse will be rewarded with higher credit for performing these gaits on the correct lead and with an alert attitude.
- Horses are to be shown at a ground-covering walk, working trot, and lope. The horse should perform with a reasonably loose rein that maintains contact with the horse,
- A distance of at least 30 feet or more is mandatory between obstacles to evaluate the horse's way of going at each gate.
- The judge may walk the course and has the right and duty to alter the course in any manner. The judge may remove or change any obstacle he deems unsafe or unreasonable. If at any time a trail obstacle is deemed unsafe by the judge, it shall be repaired or removed from the course. If it cannot be repaired and horses have completed the course, the score for that obstacle shall be deducted from all previous works for that class.

Obstacles:

1. Opening, passing through and closing the gate. Use a gate that will not endanger horse or rider. The rein hand may be changed to work the gate without penalty if the change is made prior to and after the gate has been worked.
2. Put on and remove slicker. Rider Approaches slicker, removes slicker from a holder, puts on slicker and replaces slicker to holder.
3. Log drag- **Advanced only.** Horse must be willing to drag a log for a short distance, either in a straight line or around a set pattern. Rope should be dallied around the saddle horn and not tied hard and fast. A five-point penalty will be assessed for first refusal, balk, or attempting to evade an obstacle by shying or backing more than two strides away. An additional five-point penalty will be assessed for the second refusal, balk, or attempting to evade an obstacle by shying or backing more than two strides away.

4. Water hazard- the horse should show willingness to cross a small ditch or shall pond (or simulated water obstacle).
5. Hobble or ground tie (contestant's option) – the horse shall remain in place while the rider dismounts and performs a normal ranch task such as moving a rail, moving a bale of hay, etc.
6. The horse shall remain quiet while the rider dismounts, removes the bit completely from the horse's mouth and re-bridles, and then picks up all four of the horse's feet. The horse should remain still and quiet as the rider remounts, leaving a loose rein. Exhibitors have the option of using a mounting block to remount. Once the rider is settled into the saddle and is still, he or she may then move the horse forward.
7. Remove, carry, and replace item. – Requires exhibitor to carry or remove an item that is used everyday on horse back such as mail from a mailbox, sack, rope, etc.
8. Bridge- Horse shows willingness to walk across obstacle designed to stimulate a bridge.
9. Crossing obstacle- While mounted the horse would walk over an obstacle no more than 18 inches in height.
10. Ride over at least four logs- Walking only if laid at odd angles. Laid flat and in measured distances, the measuring point should be the path the horse would be expected to take. Trot overs 2'6" to 3'6" and lope overs 6' to 7'.
11. Back
12. Stationary steer- this obstacle is used to show the willingness of the horse to have a rope thrown from its back. The judge will give credit to the horse that stands quietly while the contestant makes the swing and throws at the stationary steer. Shying from the rope will be penalized, but missing the stationary steer will not be penalized.
13. Side Pass- a judge has the right and duty to alter the course in any manner or remove any obstacle deemed unsafe. All courses and obstacles are to be constructed with safety in mind so as to eliminate any possible accidents. It is permissible to change rein hand to work an obstacle. An exhibitor that does not perform an obstacle or performs an obstacle incorrectly is assessed. A 10-point penalty and cannot place over another exhibitor that performs the course correctly.

Green Horse- Obstacles 1,2, and 2 others

Amateur- Obstacles 1,2 and 3 others

Intermediate- Obstacles 1,2,8, and 3 others

Advanced- 1,2,3,8, and 4 others

Penalty Points:

Scoring will be on the basis of 0 to infinity, with 70 denoting an average performance. Each obstacle will receive an obstacle score that should be added or subtracted from 7- and is subject to a penalty that should be subtracted. Each obstacle will be scored on the following basis, ranging from 1 ½ to minus 1 ½ :

- -1 ½ Needs extreme improvement
- -1 Needs extreme improvement
- -½ Needs improvement
- 0 Correct
- + ½ Good
- +1 Very good
- +1 ½ Excellent

Obstacle scores are to be determined and assessed independently of penalty points. Penalties should be assessed per occurrence as follows:

- ½ point deduction
 - Each tick of log, pole, cone, plant, or any component of the obstacle.
- 1 point deducton
 - Each bite of hit of or stepping on a log, cone, plant, or any component of the obstacle.
 - Incorrect or break of gait at walk or jog for two strides or less.
 - Both front or hind feet in a single-strided slot or space.
 - Skipping over or failing to step into required space.
 - Split pole in lope over.
- 3 point deduction
 - Incorrect or break of gait at walk or jog for more than 2 strides.
 - Out of lead or break of gait at lope (except when correcting an incorrect lead).
 - Knocking down an elevated pole, cone, barrel, plant, obstacle, or severely disturbing an obstacle.
 - Stepping outside the confines of, falling or jumping off or out of obstacle with one foot once with foot has entered the obstacle. Including missing one element of an obstacle on a line of travel with one foot.
- 5 point deduction
 - Dropping slicker or object required to be carried on the course.
 - First or second cumulative refusal, balk, or evading an obstacle by shying or backing.
 - Letting go of gate or dropping rope gate.
 - Use of either hand to instill fear or praise.
 - Blatant disobedience. (including kicking out, bucking, rearing, and striking.)
 - Faults which occur on the line of travel between obstacles scored accordign to severity:
 - Head carried too high
 - Head carried too low
 - Over flexing or straining neck in head carriage so the nose is carried behind the vertical
 - Excessive nosing out
 - Opening mouth excessively

FREESTYLE REINING

Each contestant will make up their pattern, choose their music, and style of dress.

Patterns must be submitted to the horse working group with the fair class registration.

- The pattern must be clearly drawn on a 8 ½ x 11 inch paper and given to the desingnated leader as well as the contestant's music. The pattern must include description or title, contestant name, and music with tract.
- Th patter will be two to three minutes long and contain age requirements.
- Western tack shall be used.

- Youth will perform to music and in costume. If costume is used, boots must be worn, and attire must be appropriate for riding. **Not allowed: bikini tops, halter tops, sports bras, or see-through clothing of any kind.**
- Members must enter arena, execute the pattern, and exit while mounted.
- Props may be used but should not overpower or interfere with the members routine. Keep props to the sidelines including cones. Maximum amount of props is 6.

This will be an all class division with the exception that there will be no walk trot. Maneuvers to include walk, jog, canter, back, pivot/spin, rollback, lead change- simple or flying, stop, fast and slow circles.

Scoring:

Choreography/Music 30%
 Maneuvers 40%
 Horsemanship 20%
 Willfulness of horse 10%

COSTUME CLASS

For entertainment purposes only. No dragging parts of costumes are allowed for safety concern. Appropriate attire to be approved by the horse working group before entering the arena.

DUTIES OF SHOW STAFF

For fair assign clubs for certain shows:

- 1 club responsible for trail set up, get ring stewards, tear down, and put away.
- 1 club responsible for English- get gate help, ring stewards, ribbon help, set up jumps, tear down and put away.
- 1 club responsible for working ranch horse- ring stewards, get gate help, ribbon help, set up, tear down, and put away.
- 1 club responsible for the western classes- set up patterns, rung stewards, get gate help, ribbon help, tear down, and put away,

Judges:

Judges are asked for their opinion on the day of the show. They receive instructions from the horse working group regarding classes to be exhibited, special rules pertaining to those classes, and expectations.

Judges at 4-H shows are to be instructed not to give preference for fancy “show” tack with silver. Having fancy clothes/tack with silver does not “guarantee” a placing- clean, neat, workmanlike attire, and tack is all that is required. Remember that just because someone won a class yesterday doesn’t mean that they will win it today. Every show is a new day.

Chairmen:

- Attend the pre-fair clinic.
- Coordinate with 4-H Program Assistant for needs for the show and work with trail and jump committees.
- Coordinate with pattern committee on pattern classes and post patterns the morning of the show.
- Arrange for transportation and set up of obstacles for trail classes.
- Coordinate with 4-H Program Assistant that flags are at the horse arena for the opening ceremony.
- Coordinate with 4-H Program Assistant that ribbons are at the show.
- Help enforce the rules.

Secretary:

- Runs the registration table.
- Writes down the placings for each member in each class in the horse show book. Transfers placings to placing sheet for 4-H Program Assistant.
- Timer for trail obstacles.

Ring Steward:

- A person appointed to coordinate activities for the judge within the arena or show ring.
- Act as judge's liaison, mediator between judge, exhibitors, and parents/guardians.
- The steward must keep in mind that he/she has been selected to help the judge-not advise the judge and will refrain from discussing the horses or exhibitors with the judge.
- Stewards shall not take part or seem to take part in any of the judging. The ring steward may take notes or the judge but cannot assist with the judging of a class, call disqualifications, or quote rules.
- The steward should work with the chairmen, superintendent, gate people, and announcer to help assemble the classes promptly and eliminate long delays between classes.
- The judge should request the steward to move and place horses as he advises. The steward must not allow the exhibitors to crowd up in the ring or arena.
- After the judge has reached a decision and so indicates to the steward, the steward shall then record the numbers of the exhibitors and relay the results to the announcer and secretary.

Announcer:

- Person in charge of keeping the show going in a professional, timely manner.
- Helpful to have experience in announcing and voice that projects well over the PA system.
- Will work with the superintendent, chairmen, ring steward, and gate person to assemble classes promptly and eliminate long delays between classes.
- Will announce all the classes and exhibitors in each class and will announce when class is complete. For individual pattern classes will announce class, who's on deck, and who's in the hole.
- Will announce a series of gate calls for each class.
 - 1st gate call: at the beginning of the current class. If 1st class of the day, 1st gate call will be 20 minutes prior to the start of the class.
 - 2nd gate call: midway through the current class. If 1st class of the day, 2nd gate call will be 10 minutes before class.
 - 3rd gate call: End of current class. If first class of the day, 3rd gate call will be 2 minutes before class.

- 4th gate call: as the current class is exiting the arena.
- Will announce next coming up.
- Give instructions to the exhibitors per ring steward per judge.
- Will announce exhibitors placing.
- For trail, when advised by the secretary, announce for the exhibitor to move on to the next obstacle

Gate Person:

- Work with chairmen, superintendent, ring steward, and announcer to help assemble the classes promptly and eliminate long delays between classes.
- Proper and timely class set-up, class maintenance, and tear down.
- Responsible for class check in at gate and safe, timely clearing after classes.

Awards Presenter:

- Present the ribbons to the participants as they ride out of the arena. Make sure they know the correct ribbons to present to the participants.

Appendix

Dog & Horse Verification of Vaccines